

2022

contract



Siesta
exclusive



Siesta exclusive

Siesta, established in 1987, offers to an international public satisfying the most varied needs, through products conceived in the name of functionality and design.

The continuous attention to the needs and tendencies of the market has led to a constant and balanced development throughout time, determining a first hand position for both productive capacity and also from a commercial point of view. This has been possible thanks to constant research on productive and technological aspects and also on the esthetics and on product promotion.

The freshness of the design of Siesta tables and chairs together with the competitive price satisfies different levels of needs. These characteristics give Siesta access to different market sectors, for example contract and domestic.

The collection includes chairs, bar stools and tables, all designed to be multifunctional and multi-purpose, user friendly and with an indisputable style. With their colour, sense of irony, play on senses and unique forms, Siesta products are immediately recognizable throughout the world, offering longlasting, practical enjoyment. Today Siesta exports 75% of its production to 80 countries around the globe through its comprehensive network of agents and dealers.

Siesta offers an extremely wide range of indoor and outdoor products, with innumerable colour variations, with plastic materials like polypropylene and fiberglass matched to wood or metal or latest trend like transparent polycarbonate or glossy PA6 nylon, with strong technical characteristics, that give the product inimitable qualities such as softness, opaqueness, flexibility and resistance to atmospheric agents.

A concentrate of quality that makes the Siesta product so unique and special.



CHECKLIST OF OBJECTS

| | | | | | |
|---|---|---|---|---|---|
| CHAIRS & ARMCHAIRS ▶ | |  |  |  |  |
| | | PACIFIC LOUNGE ARMCHAIR 8 | PACIFIC LOUNGE CHAIR 10 | PACIFIC ARMCHAIR 12 | SKY PRO 14 |
|  |  |  |  |  |  |
| CROSS XL 28 | MARCEL 30 | MARCEL XL 32 | DREAM 34 | MONNA 36 | LISA 38 |
|  |  |  |  |  |  |
| SNOW 52 | MOON 54 | FLASH 56 | BLOOM 58 | AIR XL 60 | AIR 62 |
|  |  |  |  |  |  |
| CRYSTAL 76 | ELIZABETH 78 | BABY ELIZABETH 80 | ELIZABETH-C 82 | ARTHUR 84 | BO 86 |
|  |  |  |  |  |  |
| MIO-PP 100 | MIO 102 | MAYA 104 | DIVA 106 | BOX 108 | BOX SOFA 110 |
|  |  |  |  |  |  |
| LUCCA-T 124 | DOLCE 126 | VITA 128 | ROMEO 130 | JULIETTE 132 | GALA 134 |

| | | | | | |
|---|---|---|---|---|---|
|  |  |  |  |  |  |
| SKY 16 | SKY LOUNGE 18 | MARIE 20 | VICTOR 22 | VICTOR XL 24 | CROSS 26 |
|  |  |  |  |  |  |
| LUCY 40 | LOFT 42 | MILA 44 | PIA 46 | SUNSET 48 | PLUS 50 |
|  |  |  |  |  |  |
| MIRANDA 64 | SOHO 66 | JOSEPHINE 68 | NAPOLEON 70 | OPERA 72 | CHIAVARI 74 |
|  |  |  |  |  |  |
| BEE 88 | MISS BIBI 90 | MR BOBO 92 | CARMEN 94 | ALLEGRA 96 | ALLEGRA-PP 98 |
|  |  |  |  |  |  |
| ARES 112 | ARTEMIS 114 | ARTEMIS XL 116 | TIFFANY 118 | TIFFANY-S 120 | LUCCA 122 |
|  | LOUNGE ▶ | |  | |  |
| BELLA 136 | | | PACIFIC LOUNGE SET WITH ARMS 138 | | PACIFIC LOUNGE SET WITHOUT ARMS 140 |

CHECKLIST OF OBJECTS

| | | | | | |
|---|---|---|--|---|---|
|  |  |  |  | | |
| PACIFIC LOUNGE EXTENSION PART 142 | PACIFIC LOUNGE SOFA ARMCHAIR 144 | PACIFIC LOUNGE SOFA CHAIR 146 | MYKONOS LOUNGE SET XL 148 | | |
|  |  | SUNLOUNGER ▶ | |  |  |
| MYKONOS LOUNGE TABLE XL 164 | MYKONOS EXTENSION PART 166 | | | SLIM 168 | PACIFIC 170 |
|  |  |  |  |  |  |
| MARCEL BAR 75 180 | MARCEL BAR 65 182 | MAYA BAR 75 184 | MAYA BAR 65 186 | ARES BAR 75 188 | OPERA BAR 75 190 |
|  |  |  |  |  |  |
| AIR BAR 65 204 | ARIA 206 | GIO 75 208 | QUEEN 210 | SKY SIDE TABLE 212 | SKY LOUNGE TABLE 214 |
|  |  |  |  |  |  |
| VEGAS TABLE XL 226 | VEGAS BAR 100 228 | SKY FOLDING TABLE 60 230 | SKY FOLDING TABLE Ø60 232 | SKY TABLE 70 234 | SKY TABLE 80 236 |
|  |  |  |  |  |  |
| AIR LEGS MEDIUM 248 | AIR LEGS XL 248 | OCTOPUS 60 250 | OCTOPUS BAR 252 | SKY FOLDING BAR TABLE 60 254 | SKY FOLDING BAR TABLE Ø60 256 |

| | | | | | |
|---|---|---|---|---|---|
|  | |  | |  |  |
| MYKONOS LOUNGE SET 152 | | MYKONOS LOUNGE CORNER SET 156 | | MYKONOS LOUNGE ARMCHAIR 160 | MYKONOS LOUNGE TABLE 162 |
| STOOLS & COMPLEMENTS ▶ | | |  |  |  |
| | | | VICTOR BAR 75 172 | VICTOR BAR 65 174 | CROSS BAR 75 176 |
|  |  |  |  |  |  |
| OPERA BAR 65 192 | CHIAVARI BAR 75 194 | CHIAVARI BAR 65 196 | FOX 75 198 | FOX 65 200 | AIR BAR 75 202 |
|  |  |  | TABLES ▶ | |  |
| BOX TABLE 216 | OCEAN SIDE TABLE 218 | OCEAN TABLE 220 | | | VEGAS TABLE 222 |
|  |  |  |  |  |  |
| AIR TABLE 80 238 | AIR TABLE 140 240 | AIR TABLE 180 242 | SKY FOLDING LEGS 244 | SKY LEGS 246 | AIR LEGS SMALL 248 |
|  |  |  |  |  |  |
| ARES 80 258 | ARES 140 260 | MAYA 80 262 | MAYA 120 262 | MAYA 140 262 | ICE 268 |

CHECKLIST OF OBJECTS

| | | | | | |
|---|---|---|--|---|---|
|  |  |  |  |  |  |
| ICE 268 | ICE LEG&BASE 272 | MANGO 274 | MANGO ALU 276 | FORZA 278 | SORTIE 280 |
|  |  | LIGHTING ▶ | |  |  |
| POPPY 282 | ELFO 284 | | | DODO 286 | NOVA 288 |
|  | LINKING ▶ | | CUSHION ▶ | |  |
| SMART 290 |  | | | | ARTEMIS XL CUSHIONS 294 |
|  | |  | | Siesta exclusive | |
| MYKONOS CUSHIONS 296 | | SLIM CUSHIONS 298 | | siesta.com.tr | |



8 Pacific Lounge Armchair



Pacific stacking lounge armchair with Batyline fabric from Serge Ferrari is made from a weather-proof, UV-protected resin reinforced by glass fiber that stands up to summer showers and strong sun, making it the ideal, worry-free addition to your outdoor seating area. For domestic or commercial use.

232 Pacific Lounge Armchair

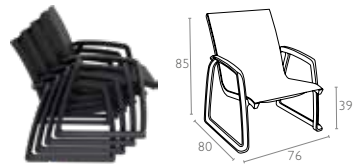

Colors



Pacific Lounge Chair



Pacific stacking lounge chair with Batyline fabric from Serge Ferrari is made from a weather-proof, UV-protected resin reinforced by glass fiber that stands up to summer showers and strong sun, making it the ideal, worry-free addition to your outdoor seating area. For domestic or commercial use.

231 Pacific Lounge Chair

CATAS
TEST REPORT

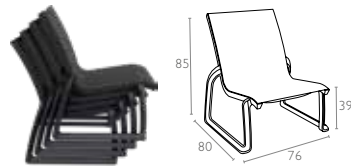

Serge Ferrari

Colors



White / White

Black / Black

Taupe / Taupe

Dark Grey / Black



Pacific Armchair



Pacific armchair with Batyline fabric from Serge Ferrari is made from a weather-proof, UV-protected resin reinforced by glass fiber that stands up to summer showers and strong sun, making it the ideal, worry-free addition to your outdoor seating area. This versatile armchair pairs perfectly with the Pacific sunlounger, as well as a wide range of other outdoor tables. For domestic or commercial use.

023 Pacific Armchair

CATAS
TEST REPORT
308018

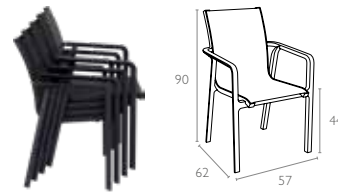

Serge Ferrari

Colors



White / White Black / Black Taupe / Taupe Dark Grey / Black



Sky Pro



Sky Pro stacking armchair is produced with a single injection of polypropylene reinforced with glass fiber obtained by means of the latest generation of air moulding technology with neutral tones. For indoor and outdoor use.

151 Sky Pro

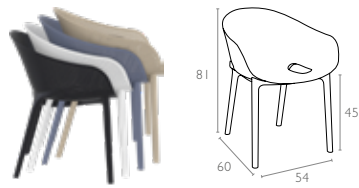

Colors



Sky



Sky armchair is produced with recyclable polypropylene seat and legs reinforced with glass fiber. For indoor and outdoor use. Can be disassembled.

102 Sky

CATAS
TEST REPORT
261210

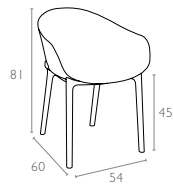

Colors



White Black Dark Grey Taupe Red



Yellow



Sky Lounge



Sky lounge chair is produced with recyclable polypropylene seat and legs reinforced with glass fiber. For indoor and outdoor use. Can be disassembled. The SKY collection also includes a coffee table, designed to match the styling silhouette of the chair to perfection.

103 Sky Lounge

CATAS
TEST REPORT
257287

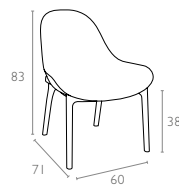

Colors

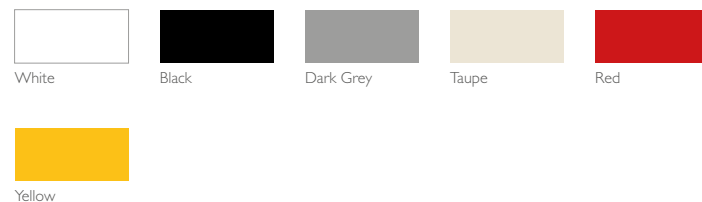



Marie stacking chair is produced with a single injection of polypropylene reinforced with glass fiber obtained by means of the latest generation of air moulding technology with neutral tones. For indoor and outdoor use.

251 Marie

CATAS
TEST REPORT
294904

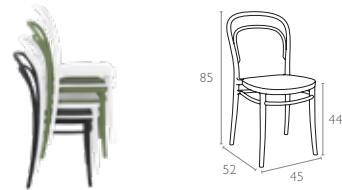

Colors



White



Black



Olive Green





Victor stacking chair is produced with a single injection of polypropylene reinforced with glass fiber obtained by means of the latest generation of air moulding technology with neutral tones. For indoor and outdoor use.

252 Victor

CATAS
TEST REPORT
294905

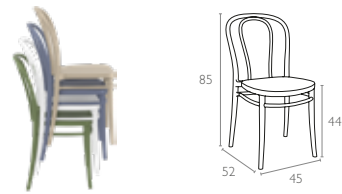

Colors



White

Black

Dark Grey

Taupe

Olive Green



Victor XL



Victor XL stacking armchair is produced with a single injection of polypropylene reinforced with glass fiber obtained by means of the latest generation of air moulding technology with neutral tones. For indoor and outdoor use.

253 Victor XL

CATAS
TEST REPORT
294886

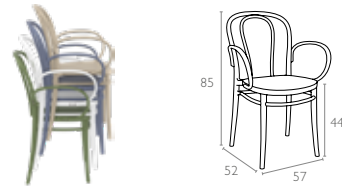

Colors



White

Black

Dark Grey

Taupe

Olive Green





Cross stacking chair is produced with a single injection of polypropylene reinforced with glass fiber obtained by means of the latest generation of air moulding technology with neutral tones. For indoor and outdoor use.

254 Cross

CATAS
TEST REPORT
294906

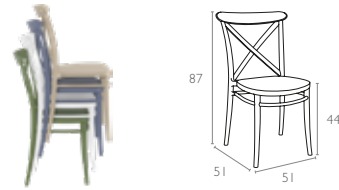

Colors



White

Black

Dark Grey

Taupe

Olive Green



Cross XL



Cross XL stacking armchair is produced with a single injection of polypropylene reinforced with glass fiber obtained by means of the latest generation of air moulding technology with neutral tones. For indoor and outdoor use.

256 Cross XL

CATAS
TEST REPORT
294885

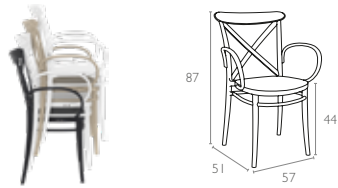

Colors





Marcel stacking chair is produced with a single injection of polypropylene reinforced with glass fiber obtained by means of the latest generation of air moulding technology with neutral tones. For indoor and outdoor use.

257 Marcel

CATAS
TEST REPORT
294903

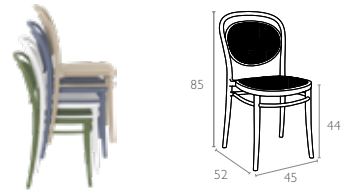

Colors



White

Black

Dark Grey

Taupe

Olive Green



Marcel XL



Marcel XL stacking armchair is produced with a single injection of polypropylene reinforced with glass fiber obtained by means of the latest generation of air moulding technology with neutral tones. For indoor and outdoor use.

258 Marcel XL

CATAS
TEST REPORT
294887

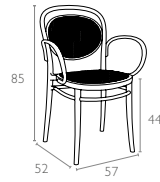

Colors



White



Black



Dark Grey

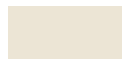

Taupe



Olive Green





Dream folding chair is produced with a single injection of polypropylene reinforced with glass fiber obtained by means of the latest generation of air moulding technology with neutral tones. For indoor and outdoor use.

079 Dream

CATAS
TEST REPORT
294880

designed by
Frédéric Boonen
bds

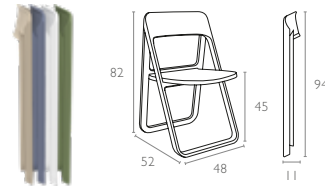

Colors



White Black Dark Grey Taupe Red



Olive Green





Monna chair is produced with a single injection of polypropylene reinforced with glass fiber obtained by means of the latest generation of air moulding technology with neutral tones. For indoor and outdoor use.

127 Monna

CATAS
TEST REPORT
276554

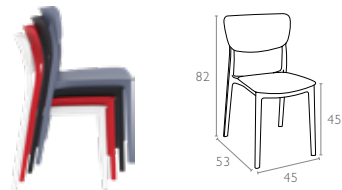

Colors



White

Black

Dark Grey

Taupe

Red



Olive Green





Lisa armchair is produced with a single injection of polypropylene reinforced with glass fiber obtained by means of the latest generation of air moulding technology with neutral tones. For indoor and outdoor use.

126 Lisa

CATAS
TEST REPORT
276570

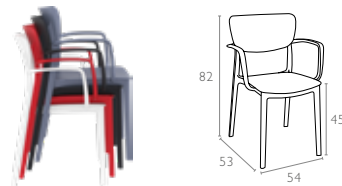

Colors



White Black Dark Grey Taupe Red



Olive Green





Lucy chair is produced with a single injection of polypropylene reinforced with glass fiber obtained by means of the latest generation of air moulding technology with neutral tones. For indoor and outdoor use.

129 Lucy

CATAS
TEST REPORT
276562



Colors



White

Black

Dark Grey

Taupe

Olive Green





Loft armchair is produced with a single injection of polypropylene reinforced with glass fiber obtained by means of the latest generation of air moulding technology with neutral tones. For indoor and outdoor use.

128 Loft

CATAS
TEST REPORT
276563

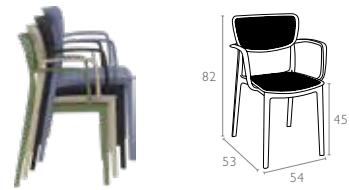

Colors



White

Black

Dark Grey

Taupe

Olive Green





Mila armchair is produced with a single injection of polypropylene reinforced with glass fiber obtained by means of the latest generation of air moulding technology with neutral tones. For indoor and outdoor use.



085 Mila

CATAS
TEST REPORT
233341

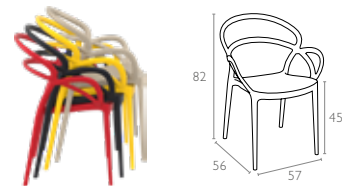

Colors



Yellow





Pia chair is produced with a single injection of polypropylene reinforced with glass fiber obtained by means of the latest generation of air moulding technology with neutral tones. For indoor and outdoor use.



086 Pia

CATAS
TEST REPORT
233342

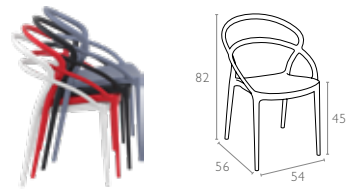

Colors



White

Black

Dark Grey

Taupe

Red



Yellow





Sunset chair is produced with a single injection of polypropylene reinforced with glass fiber obtained by means of the latest generation of air moulding technology with neutral tones. For indoor and outdoor use.



088 Sunset

CATAS
TEST REPORT
233343

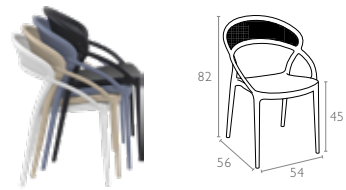

Colors



White

Black

Dark Grey

Brown

Taupe





Plus armchair is produced with a single injection of polypropylene reinforced with glass fiber obtained by means of the latest generation of air moulding technology with neutral tones. For indoor and outdoor use.

093 Plus

CATAS
TEST REPORT
235829

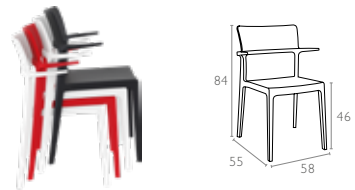

Colors



White

Black

Red





Snow chair is produced with a single injection of polypropylene reinforced with glass fiber obtained by means of the latest generation of air moulding technology with neutral tones. For indoor and outdoor use.

092 Snow

CATAS
TEST REPORT
235827

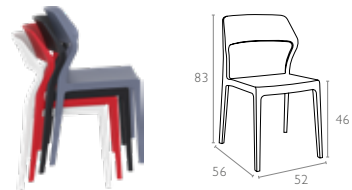

Colors



White

Black

Dark Grey

Taupe

Red



Yellow



Olive Green





Stacking chair with the latest generation of air moulding thermoplastic injection. Seat in polypropylene reinforced with glass fiber, backrest in transparent polycarbonate. For indoor and outdoor use.

090 Moon

CATAS
TEST REPORT
235828

Made with
Makrolon®
The high-tech polycarbonate

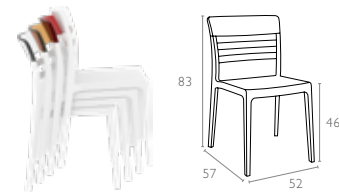

Colors

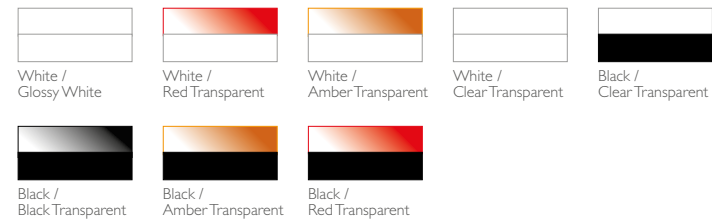



Stacking chair with the latest generation of air moulding thermoplastic injection. Seat in polypropylene reinforced with glass fiber, backrest in transparent polycarbonate. For indoor and outdoor use.

091 Flash

CATAS
TEST REPORT
235828

Made with
Makrolon®
The high-tech polycarbonate

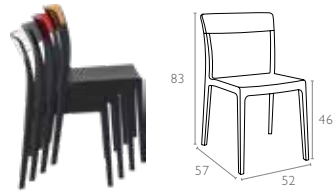

Colors

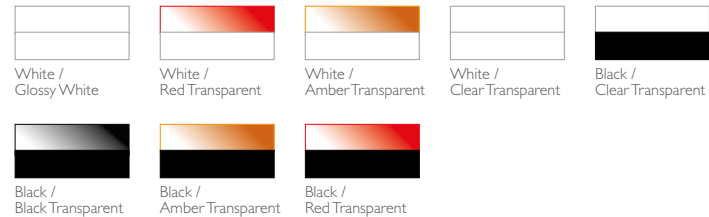



Bloom chair is produced with a single injection of polypropylene reinforced with glass fiber obtained by means of the latest generation of air moulding technology with neutral tones. For indoor and outdoor use.

048 Bloom

CATAS
TEST REPORT
207974

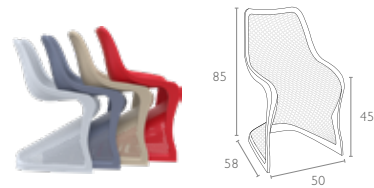

Colors



White Black Dark Grey Silver Grey Taupe



Red Yellow





Air XL armchair is produced with a single injection of polypropylene reinforced with glass fiber obtained by means of the latest generation of air moulding technology with neutral tones. For indoor and outdoor use.

007 Air XL

CATAS
TEST REPORT
182331

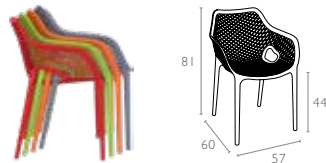

Colors





Air chair is produced with a single injection of polypropylene reinforced with glass fiber obtained by means of the latest generation of air moulding technology with neutral tones. For indoor and outdoor use.

014 Air

CATAS
TEST REPORT
163635



Colors



White

Black

Dark Grey

Red

Taupe



Tropical Green



Orange



Yellow





Miranda chair is produced with a single injection of polypropylene reinforced with glass fiber obtained by means of the latest generation of air moulding technology with neutral tones. For indoor and outdoor use.

039 Miranda

CATAS
TEST REPORT
201779

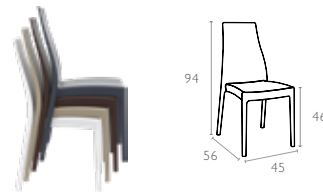

Colors





Soho chair is produced with a single injection of polypropylene reinforced with glass fiber obtained by means of the latest generation of air moulding technology with neutral tones. For indoor and outdoor use.

054 Soho

CATAS
TEST REPORT
201772

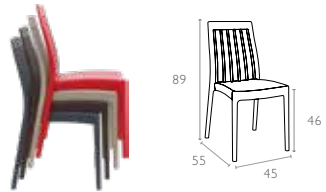

Colors



White

Black

Dark Grey

Brown

Taupe



Red





Josephine wedding chair is produced with a single injection of polypropylene reinforced with glass fiber obtained by means of the latest generation of air moulding technology with neutral tones. For indoor and outdoor use.

050 Josephine

CATAS
TEST REPORT
201775

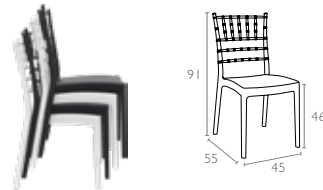

Colors



White



Black



Napoleon



Napoleon wedding chair is produced with a single injection of polypropylene reinforced with glass fiber obtained by means of the latest generation of air moulding technology with neutral tones. For indoor and outdoor use.

044 Napoleon

CATAS
TEST REPORT
201775

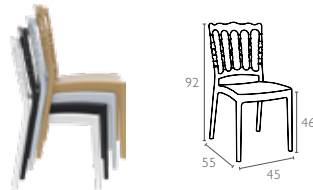

Colors



White

Black

Silver Grey

Gold





Stacking wedding chair for indoor and outdoor use in clear or shiny polycarbonate. Scratch resistant, UV - resistant.

061 Opera

CATAS
TEST REPORT
226345

Made with
Makrolon®
The high-tech polycarbonate

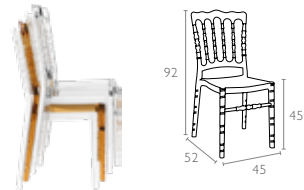

Colors



Glossy White Amber Transparent Clear Transparent

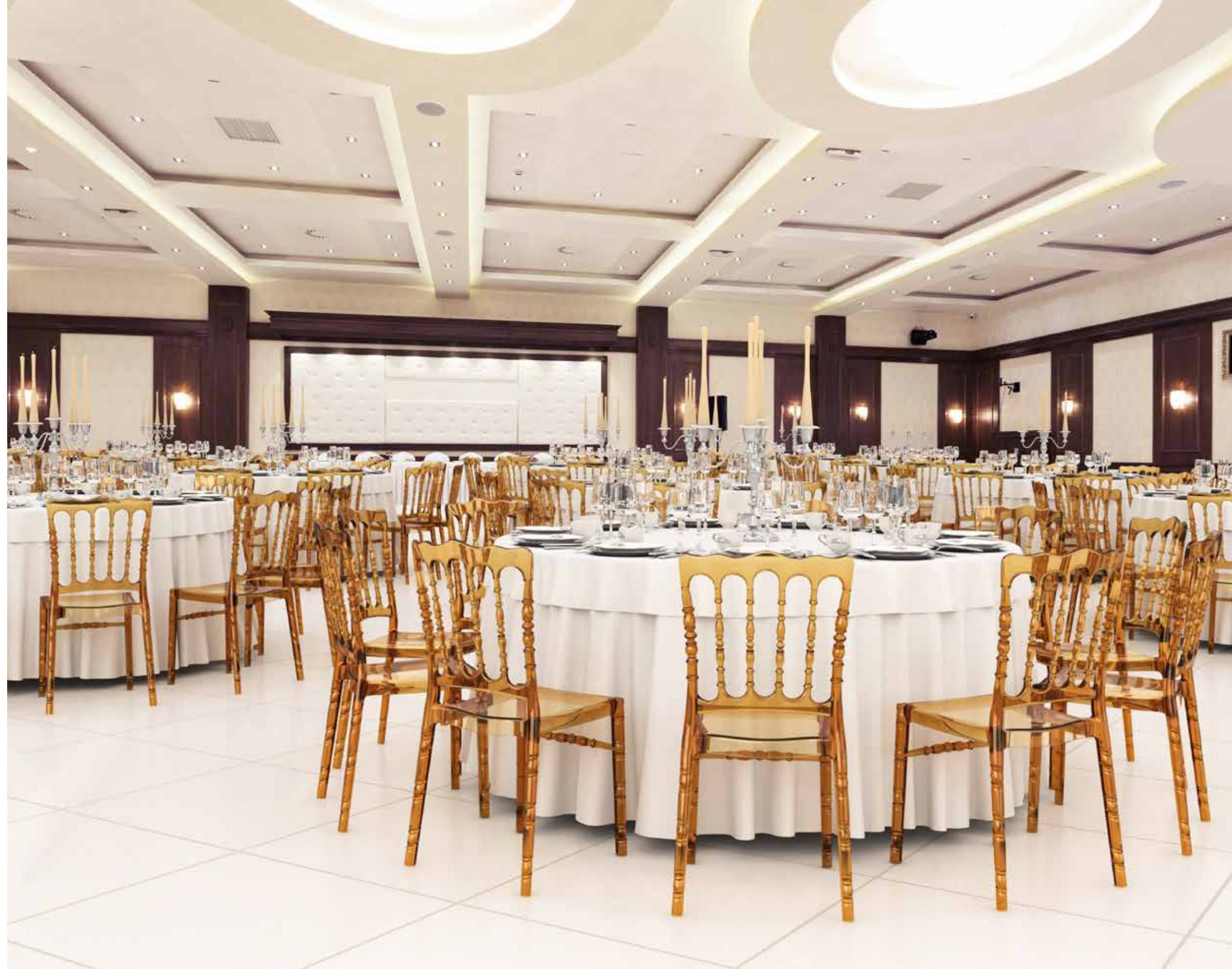



Stacking wedding chair for indoor and outdoor use in clear or shiny polycarbonate. Scratch resistant, UV - resistant.

071 Chiavari

CATAS
TEST REPORT
226347

Made with
Makrolon®
The high-tech polycarbonate

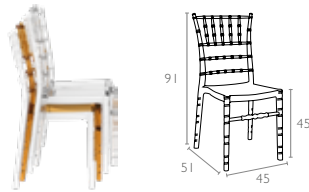

Colors



Glossy White

Amber Transparent

Clear Transparent





Stacking armchair for indoor and outdoor use in clear polycarbonate moulded with gas technology of the second generation. Scratch resistant, UV - resistant.

052 Crystal

CATAS
TEST REPORT
108091

Made with
Makrolon®
The high-tech polycarbonate

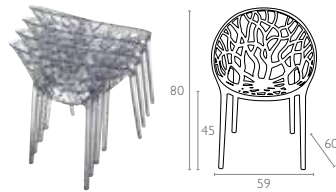

Colors

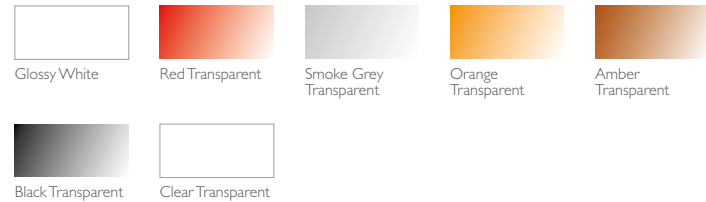



Stacking chair for indoor and outdoor use in shiny technopolymer PA6 nylon or clear polycarbonate. Scratch resistant, self-extinguishing classification V2, UV-resistant.

034 Elizabeth

CATAS
TEST REPORT
107368

Made with
Makrolon®
The high-tech polycarbonate

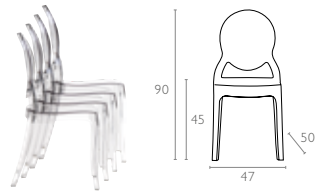

Colors

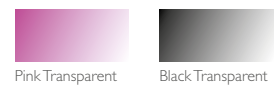

Baby Elizabeth



Stacking children chair Baby Elizabeth for indoor and outdoor use in clear polycarbonate. Scratch resistant, UV – resistant.

051 Baby Elizabeth

CATAS
TEST REPORT
120253

Made with
Makrolon®
The high-tech polycarbonate

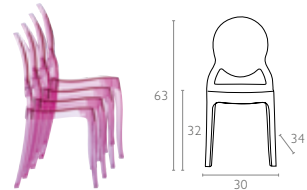

Colors

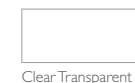

Clear Transparent





Stacking chair for indoor use with removable cushion on the seat, in shiny technopolymer PA6 nylon or clear polycarbonate.

034 Elizabeth-C

CATAS
TEST REPORT
107368

Made with
Makrolon®
The high-tech polycarbonate

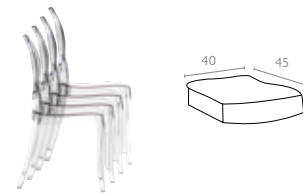

Cushion Colors

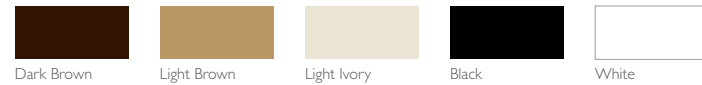

Dark Brown

Light Brown

Light Ivory

Black

White





Stacking armchair for indoor and outdoor use in shiny technopolymer PA6 nylon or clear polycarbonate. Scratch resistant, self - extinguish classification V2, UV - resistant.

053 Arthur

CATAS
TEST REPORT
129749

Made with
Makrolon®
The high-tech polycarbonate

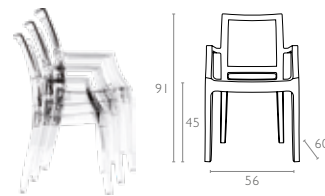

Colors



Glossy White

Glossy Red

Glossy Black

Clear Transparent

Amber Transparent



Black Transparent





Stacking chair for indoor and outdoor use in clear or shiny polycarbonate. Scratch resistant, UV - resistant.

005 Bo

CATAS
TEST REPORT
154712

Made with
Makrolon®
The high-tech polycarbonate

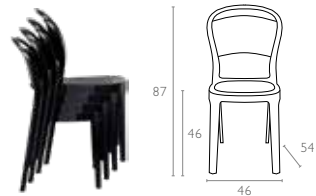

Colors

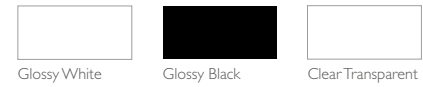

Glossy White Glossy Black Clear Transparent





Stacking chair for indoor and outdoor use in clear or shiny polycarbonate. Scratch resistant, UV - resistant.

Design By

 ILANIT OVADYA

021 Bee

CATAS
 TEST REPORT
 154712

Made with
 **Makrolon®**
 The high-tech polycarbonate

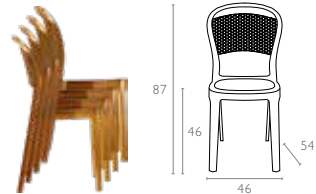

Colors



Glossy White Glossy Black Red Transparent Amber Transparent Black Transparent



Clear Transparent



Miss Bibi



Stacking chair with the latest generation of air moulding thermoplastic injection. Seat in polypropylene reinforced with glass fiber, backrest in transparent polycarbonate. For indoor and outdoor use.

055 Miss Bibi

CATAS
TEST REPORT
112744

Made with
Makrolon[®]
The high-tech polycarbonate

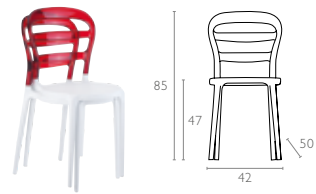

Colors





Stacking chair with the latest generation of air moulding thermoplastic injection. Seat in polypropylene reinforced with glass fiber, backrest in transparent polycarbonate. For indoor and outdoor use.

056 Mr Bobo

CATAS
TEST REPORT
112744

Made with
Makrolon®
The high-tech polycarbonate

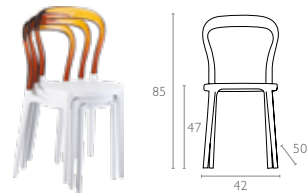

Colors

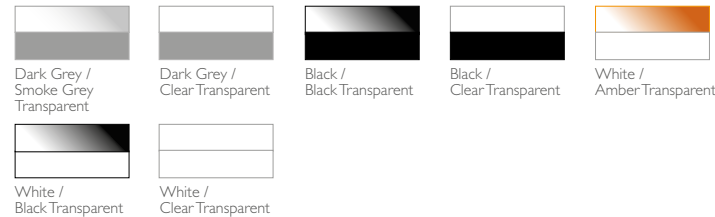



Stacking armchair with the latest generation of air moulding thermoplastic injection. Seat in polypropylene reinforced with glass fiber, backrest in transparent polycarbonate. For indoor and outdoor use.

059 Carmen

CATAS
TEST REPORT
120254

Made with
Makrolon®
The high-tech polycarbonate

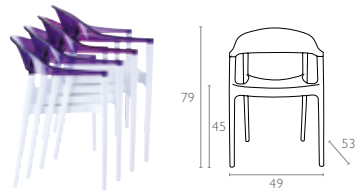

Colors

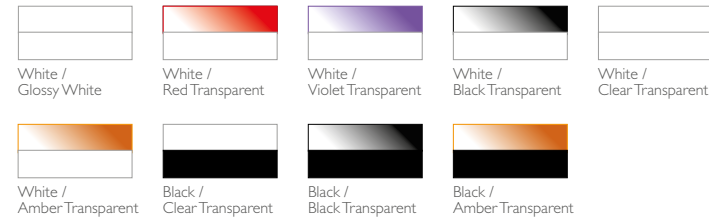

Allegra



Recyclable polycarbonate main body. Legs frame in tubular chrome steel. Stackable. For indoor use.

057 Allegra

Made with **Makrolon**[®]
The high-tech polycarbonate

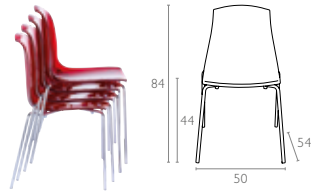

Colors



Glossy White Red Transparent Amber Transparent Black Transparent Clear Transparent





Recyclable polycarbonate main body. Legs frame in polypropylene.
For indoor and outdoor use. Can be disassembled.

096 Allegra-PP

Made with
Makrolon®
The high-tech polycarbonate

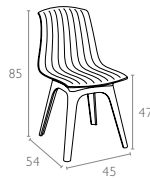

Colors



White /
Glossy White

Black /
Black Transparent

Brown /
Glossy White





Mio-PP chair is produced with recyclable polypropylene seat and legs reinforced with glass fiber. For indoor and outdoor use. Can be disassembled.

094 Mio-PP

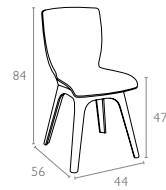

Colors

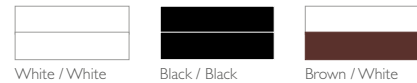

White / White

Black / Black

Brown / White





Stacking chair with recyclable polypropylene seat and backrest and painted steel legs. For indoor use.

046 Mio

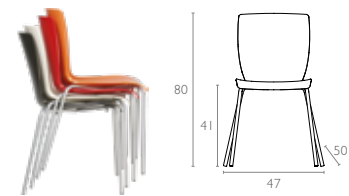

Colors



Black

Orange

Red

Beige

White





The latest generation air moulding process, as used for Maya, allows perfect control for the channel draining and the wall thickness. In designing Maya, the designers developed a formally characterized shape yet suitable for different ambiances - contemporary, classic, informal or elegant - where it easily settles in, thanks to a colour range including brights as well as neutral tones. For indoor and outdoor use.

025 Maya

CATAS
TEST REPORT
73610

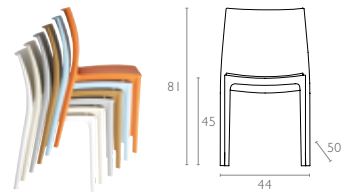

Colors

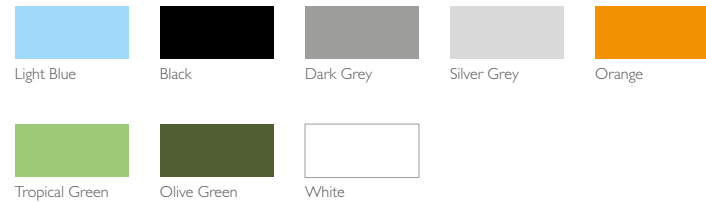



Diva armchair is produced with a single injection of polypropylene reinforced with glass fiber obtained by means of the latest generation of air moulding technology with neutral tones. For indoor and outdoor use.

028 Diva

CATAS
TEST REPORT
101128

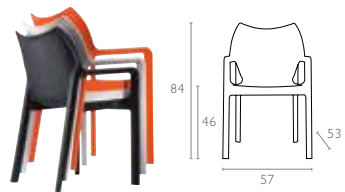

Colors





Recyclable polypropylene stacking armchair, strong and stable.
Suitable for outdoor contract use.

058 Box

CATAS
TEST REPORT
117039

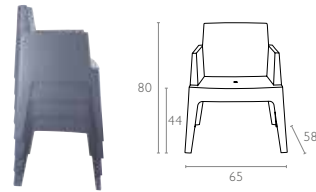

Colors



Black

Red

Silver Grey

Dark Grey

Tropical Green



Orange



White



Box Sofa



Recyclable polypropylene stackable sofa, very sturdy and stable.
Suitable for outdoor contract use.

063 Box Sofa

CATAS
TEST REPORT
152392

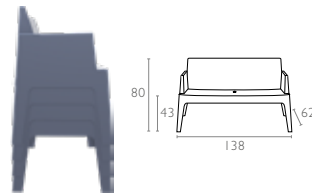

Colors





Ares chair is produced with a single injection of polypropylene reinforced with glass fiber obtained by means of the latest generation of air moulding technology with neutral tones. For indoor and outdoor use.

009 Ares

CATAS
TEST REPORT
163637

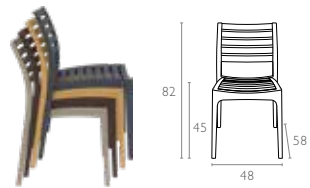

Colors



White

Black

Dark Grey

Silver Grey

Brown



Taupe



Teak



Artemis



Artemis armchair is produced with a single injection of polypropylene reinforced with glass fiber obtained by means of the latest generation of air moulding technology with neutral tones. For indoor and outdoor use.

011 Artemis

CATAS
TEST REPORT
163636

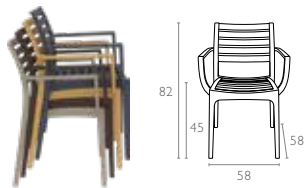

Colors

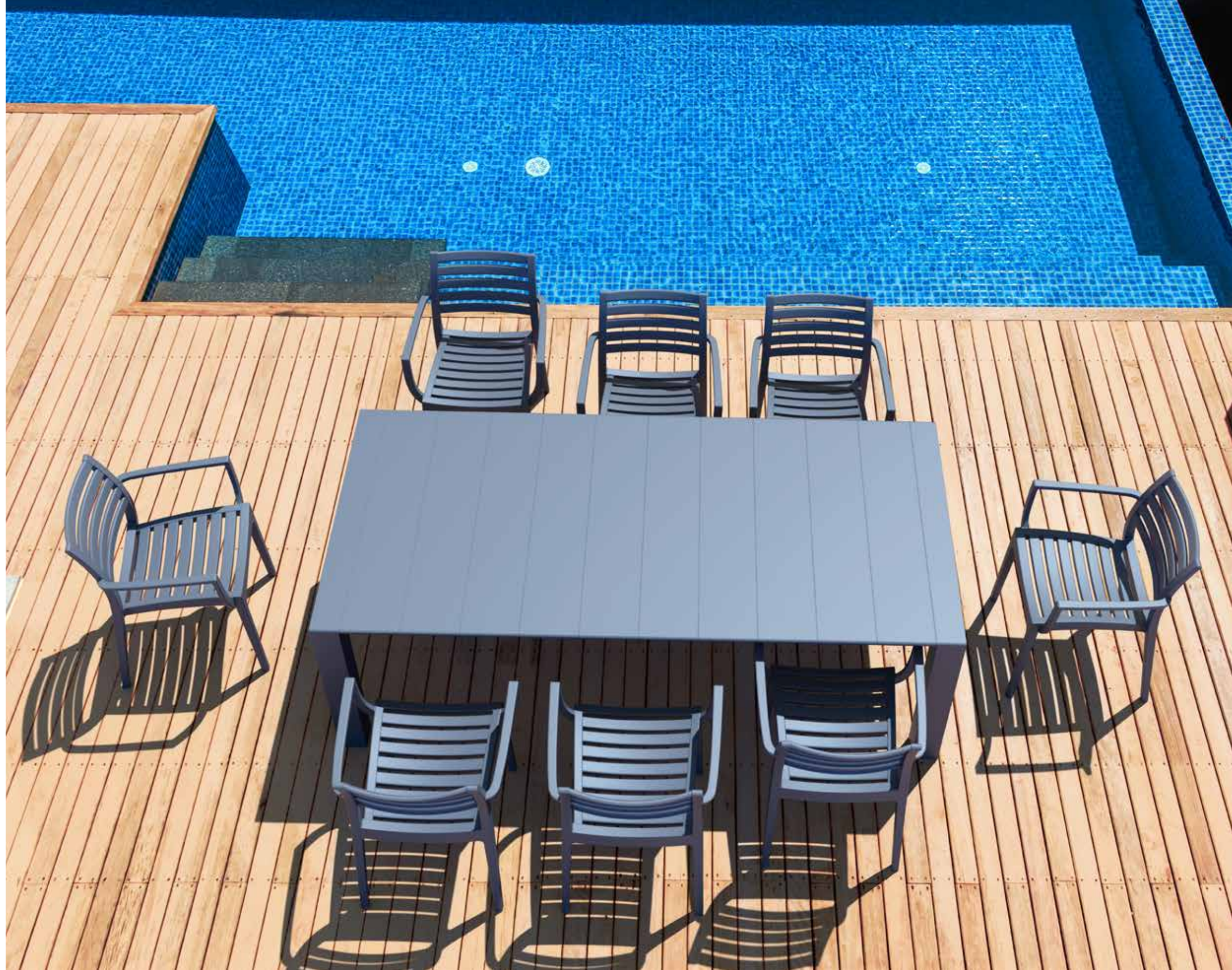
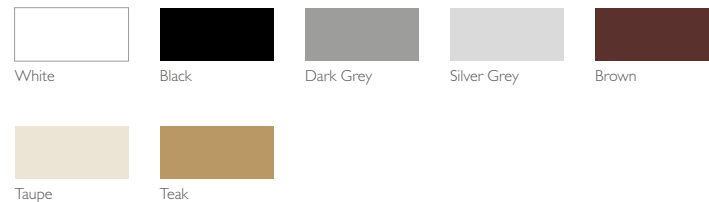

Artemis XL



Artemis XL Lounge armchair is stackable and produced with a single injection of polypropylene reinforced with glass fiber, for indoor and outdoor use with or without cushion and non-slip feet. The Artemis collection also includes a coffee table, in various sizes, designed to match the styling silhouette of the chair to perfection.

004 Artemis XL

CATAS
TEST REPORT
184080

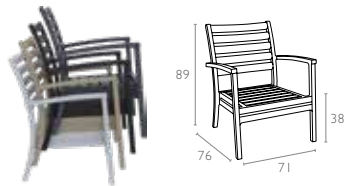

Colors



Black

Dark Grey

Silver Grey

Taupe

White





Tiffany chair is produced with a single injection of polypropylene reinforced with glass fiber obtained by means of the latest generation of air moulding technology with neutral tones. Stackable. For indoor and outdoor use.

018 Tiffany

CATAS
TEST REPORT
135690

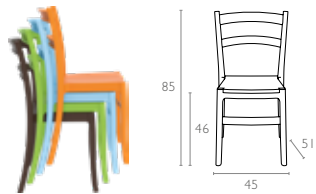

Colors



Tiffany-S



Tiffany-S chair is produced with a single injection of polypropylene reinforced with glass fiber obtained by means of the latest generation of air moulding technology with neutral tones. Stackable. For indoor and outdoor use.

019 Tiffany-S

CATAS
TEST REPORT
135690

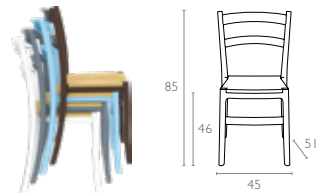

Colors



Brown

Dark Grey

Light Blue

White





Stacking chair with the latest generation of air moulding thermoplastic injection. For indoor and outdoor use.

026 Lucca

CATAS
TEST REPORT
85006

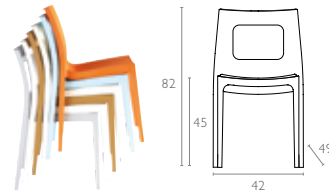

Colors



Light Blue

Dark Grey

Silver Grey

Orange

Tropical Green



White





Stacking chair with the latest generation of air moulding thermoplastic injection. Back in transparent polycarbonate.
For indoor and outdoor use.

029 Lucca-T

Made with
Makrolon®
The high-tech polycarbonate

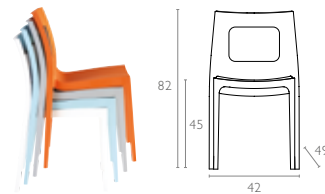

Colors



Light Blue

Orange

White





Stacking armchair with recyclable polypropylene seat and backrest and anodized aluminium legs. Diameter 25 mm. For indoor and outdoor use.

047 Dolce

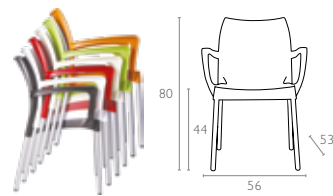

Colors



Black

Light Green

Orange

Red

Beige



Dark Grey



White





Stacking chair with recyclable polypropylene seat and backrest and anodized aluminium legs. Diameter 25 mm.
For indoor and outdoor use.

049 Vita

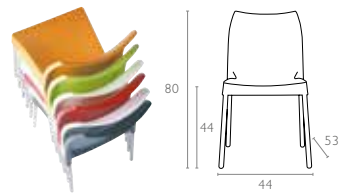

Colors



Black Light Green Orange Red Beige



Dark Grey White





Stacking armchair with recyclable polypropylene seat and backrest and anodized aluminium legs. Diameter 25 mm. For indoor and outdoor use.

043 Romeo

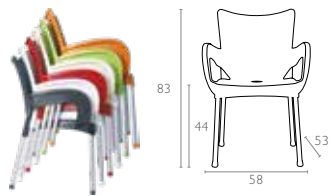

Colors



Blue

Black

Light Green

Orange

Red



Beige



White





Stacking chair with recyclable polypropylene seat and backrest and anodized aluminium legs. Diameter 25 mm. For indoor and outdoor use.

045 Juliette

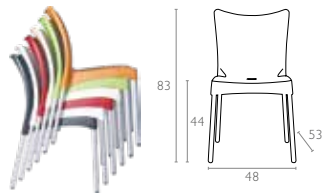

Colors



Blue

Black

Light Green

Orange

Red



Beige

White





Stacking armchair in anodized aluminium with seat and back in recyclable polypropylene with latest generation of air moulding thermoplastic injection. Diameter 25 mm. For indoor and outdoor use.

041 Gala

CATAS
TEST REPORT
79261

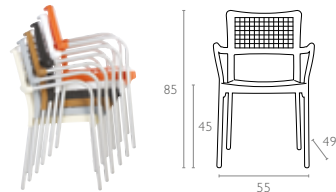

Colors



Teak

Orange

White





Stacking armchair in anodized aluminium with seat and back in recyclable polypropylene with latest generation of air moulding thermoplastic injection. Diameter 25 mm. For indoor and outdoor use.

040 Bella

CATAS
TEST REPORT
79261

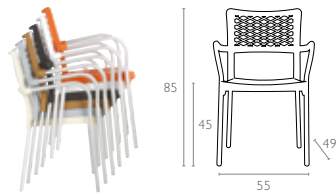

Colors



Teak

Orange

White



Pacific Lounge Set With Arms



Pacific Lounge Set with arms is designed for easy self assembly, it is made of durable weather-resistant resin reinforced with glass fiber with Batyline fabric from Serge Ferrari. Non-metallic frame will never unravel, rust or decay. It is UV protected which insures the colors will not fade. For indoor and outdoor use. Can be purchased as set or separately.

Pacific Lounge Armchair

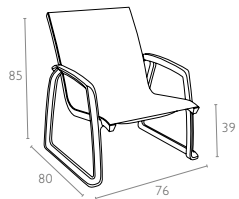

Pacific Lounge Sofa Armchair

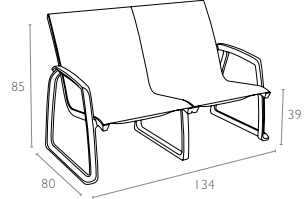

Sky Lounge Table

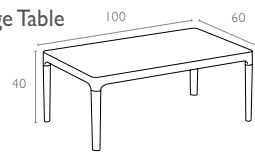

238 Pacific Lounge Set With Arms

Colors

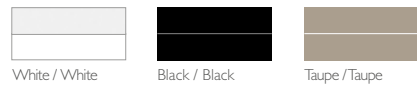

White / White Black / Black Taupe / Taupe



Pacific Lounge Set Without Arms



Pacific Lounge Set without arms is designed for easy self assembly, it is made of durable weather-resistant resin reinforced with glass fiber with Batyline fabric from Serge Ferrari. Non-metallic frame will never unravel, rust or decay. It is UV protected which insures the colors will not fade. For indoor and outdoor use. Can be purchased as set or separately.

Pacific Lounge Chair

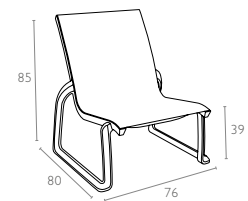

Pacific Lounge Sofa Chair

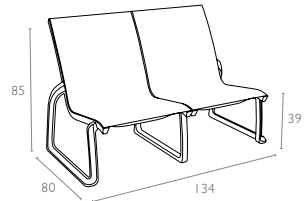

Sky Lounge Table

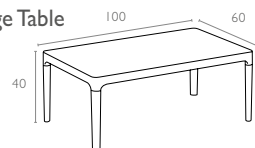

237 Pacific Lounge Set Without Arms

Colors



Pacific Lounge Extension Part



With the Pacific Lounge extension part you can add as many seats as you want to extend your Pacific Lounge Sofa with Batyline fabric from Serge Ferrari.

236 Pacific Lounge Extension Part

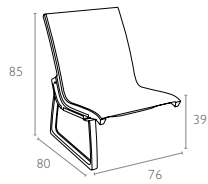

Serge Ferrari

Colors

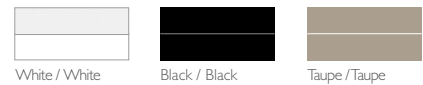

White / White Black / Black Taupe / Taupe



Pacific Lounge Sofa Armchair

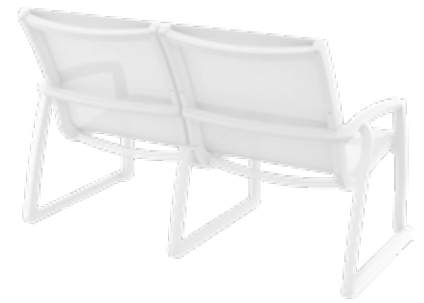

Pacific Lounge sofa with arms designed for easy self assembly with Batyline fabric from Serge Ferrari is made from a weather-proof, UV-protected resin reinforced by glass fiber that stands up to summer showers and strong sun, making it the ideal, worry-free addition to your outdoor seating area. For domestic or commercial use.

234 Pacific Lounge Sofa Armchair

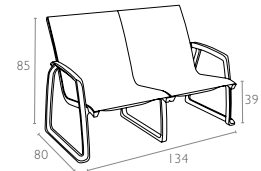

Colors



White / White Black / Black Taupe / Taupe



Pacific Lounge Sofa Chair

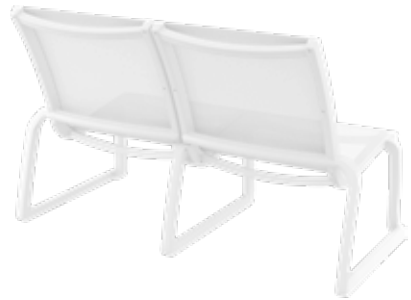

Pacific Lounge sofa without arms designed for easy self assembly with Batyline fabric from Serge Ferrari is made from a weather-proof, UV-protected resin reinforced by glass fiber that stands up to summer showers and strong sun, making it the ideal, worry-free addition to your outdoor seating area. For domestic or commercial use.

233 Pacific Lounge Sofa Chair

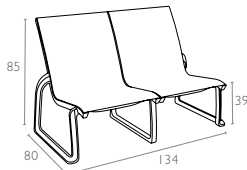

Colors

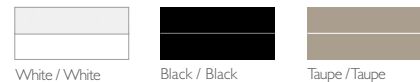

White / White Black / Black Taupe / Taupe



Mykonos Lounge Set XL



Mykonos Lounge Set XL is designed for easy self assembly, it is made of durable weather-resistant resin reinforced with glass fiber. Non-metallic frame will never unravel, rust or decay. It is UV protected which insures the colors will not fade. Can be disassembled. For indoor and outdoor contract use.

Mykonos Lounge Armchair

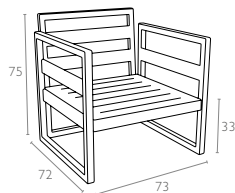

Mykonos Lounge Sofa XL

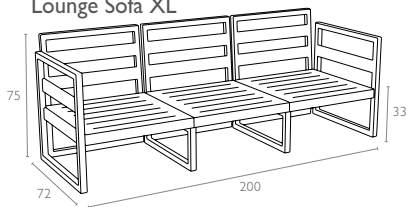

Mykonos Lounge Table XL

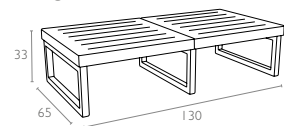

Mykonos Seat Cushion

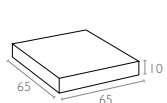

Mykonos Backrest Cushion

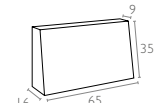

I 33 Mykonos Lounge Set XL

Colors



Cushions

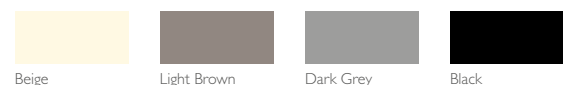

CATAS
TEST REPORT
282198





Mykonos Lounge Set



Mykonos Lounge Set is designed for easy self assembly, it is made of durable weather-resistant resin reinforced with glass fiber. Non-metallic frame will never unravel, rust or decay. It is UV protected which insures the colors will not fade. Can be disassembled. For indoor and outdoor contract use.

Mykonos
Lounge Armchair

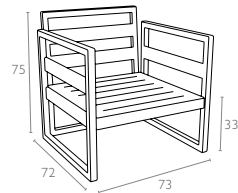

Mykonos
Lounge Sofa

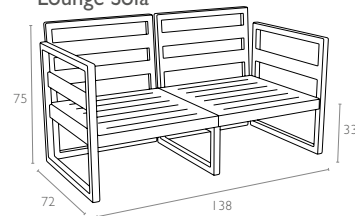

Mykonos
Lounge Table

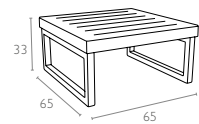

Mykonos
Seat Cushion

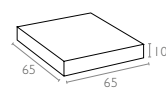

Mykonos
Backrest Cushion

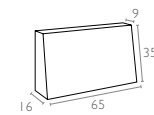

I 32 Mykonos Lounge Set

Colors



White

Taupe

Silver Grey

Cushions



Beige

Light Brown

Dark Grey

Black

etisilk
Outdoor Furniture Fabrics

CATAS
TEST REPORT
282198





Mykonos Lounge Corner Set



Mykonos Lounge Corner Set is designed for easy self assembly, it is made of durable weather-resistant resin reinforced with glass fiber. Non-metallic frame will never unravel, rust or decay. It is UV protected which insures the colors will not fade. Can be disassembled. For indoor and outdoor contract use.

Mykonos Lounge Corner

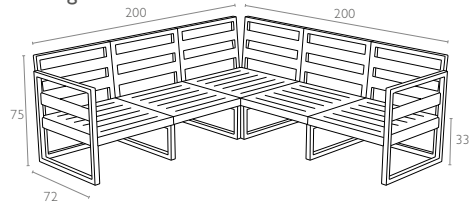

Mykonos Lounge Table

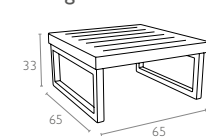

Mykonos Seat Cushion

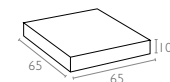

Mykonos Backrest Cushion

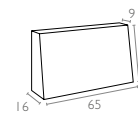

Mykonos Corner Cushion

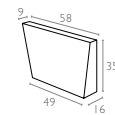

134 Mykonos Lounge Corner Set

Colors



Cushions





Mykonos Lounge Armchair



Mykonos Lounge Armchair is designed for easy self assembly, it is made of durable weather-resistant resin reinforced with glass fiber. Non-metallic frame will never unravel, rust or decay. It is UV protected which insures the colors will not fade. Can be disassembled. For indoor and outdoor contract use.

131 Mykonos Lounge Armchair

CATAS
TEST REPORT
282199

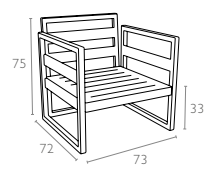

Colors



Mykonos Lounge Table



Mykonos Lounge Table is made of durable weather-resistant resin. Non-metallic frame will never unravel, rust or decay. It is UV protected which insures the colors will not fade. Can be disassembled. For indoor and outdoor use.

137 Mykonos Lounge Table

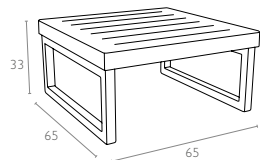

Colors



White

Taupe

Silver Grey



Mykonos Lounge Table XL



Mykonos Lounge Table XL is made of durable weather-resistant resin. Non-metallic frame will never unravel, rust or decay. It is UV protected which insures the colors will not fade. Can be disassembled. For indoor and outdoor use.

138 Mykonos Lounge Table XL

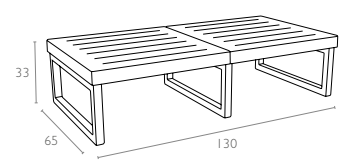

- Colors
- White
 - Taupe
 - Silver Grey



Mykonos Extension Part



With the extension part you can add as many seats as you want to extend your corner set.

136 Mykonos Extension Part

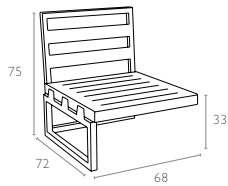

Colors



White

Taupe

Silver Grey





Slim sunlounger is stackable and comes with hidden wheels and anti-slippery rubbers. It is made of durable weather-resistant resin. Non metallic frame will never unravel, rust or decay. It is UV protected which insures the colors will not fade. For outdoor use.

087 Slim

CATAS
TEST REPORT
308019

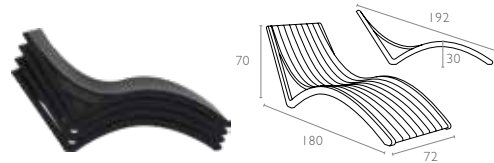

Colors



White

Black

Dark Grey

Taupe





Sunlounger without arms, tubular frame in resin reinforced with glass fiber and cover in breathable synthetic fabric (replaceable). Stackable, back reclining in 5 positions, with non-slip feet and small wheels.

089 Pacific

CATAS
TEST REPORT
178495

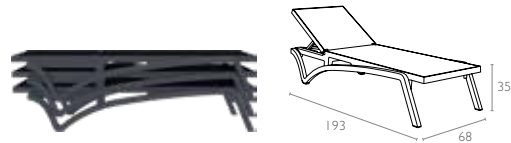

Serge Ferrari

Colors

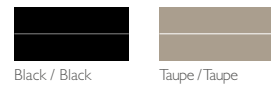
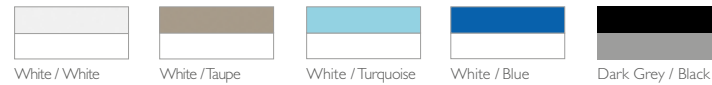

Victor Bar 75



Victor bar stool h.75 cm is produced with a single injection of polypropylene reinforced with glass fiber obtained by means of the latest generation of air moulding technology with neutral tones. For indoor and outdoor use.

262 Victor Bar 75

CATAS
TEST REPORT
294882

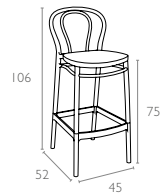

Colors



White

Black

Dark Grey

Taupe

Olive Green



Victor Bar 65



Victor bar stool h.65 cm is produced with a single injection of polypropylene reinforced with glass fiber obtained by means of the latest generation of air moulding technology with neutral tones. For indoor and outdoor use.

261 Victor Bar 65

CATAS
TEST REPORT
294882

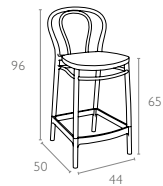

Colors



White

Black

Dark Grey

Taupe

Olive Green



Cross Bar 75



Cross bar stool h.75 cm is produced with a single injection of polypropylene reinforced with glass fiber obtained by means of the latest generation of air moulding technology with neutral tones. For indoor and outdoor use.

266 Cross Bar 75

CATAS
TEST REPORT
294881

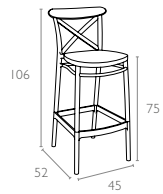

Colors



White

Black

Dark Grey

Taupe

Olive Green



Cross Bar 65



Cross bar stool h.65 cm is produced with a single injection of polypropylene reinforced with glass fiber obtained by means of the latest generation of air moulding technology with neutral tones. For indoor and outdoor use.

264 Cross Bar 65

CATAS
TEST REPORT
294881

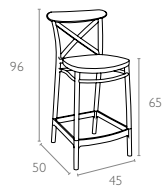

Colors



White

Black

Dark Grey

Taupe

Olive Green



Marcel Bar 75



Marcel bar stool h.75 cm is produced with a single injection of polypropylene reinforced with glass fiber obtained by means of the latest generation of air moulding technology with neutral tones. For indoor and outdoor use.

269 Marcel Bar 75

CATAS
TEST REPORT
294883

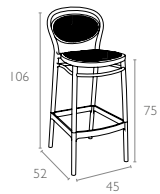

Colors



White

Black

Dark Grey

Taupe

Olive Green



Marcel Bar 65



Marcel bar stool h.65 cm is produced with a single injection of polypropylene reinforced with glass fiber obtained by means of the latest generation of air moulding technology with neutral tones. For indoor and outdoor use.

268 Marcel Bar 65

CATAS
TEST REPORT
294883

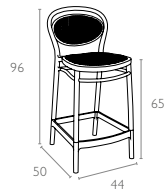

Colors



White

Black

Dark Grey

Taupe

Olive Green



Maya Bar 75



Maya stacking bar stool h.75 cm is produced with a single injection of polypropylene reinforced with glass fiber obtained by means of the latest generation of air moulding technology with neutral tones. For indoor and outdoor use.

099 Maya Bar 75

CATAS
TEST REPORT
236234

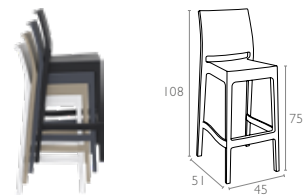

Colors



Maya Bar 65



Maya stacking bar stool h.65 cm is produced with a single injection of polypropylene reinforced with glass fiber obtained by means of the latest generation of air moulding technology with neutral tones. For indoor and outdoor use.

100 Maya Bar 65

CATAS
TEST REPORT
236234

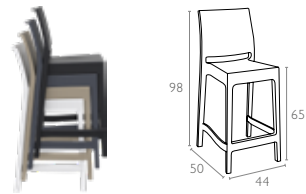

Colors



White

Black

Dark Grey

Taupe

Olive Green



Ares Bar 75



Ares stacking bar stool h.75 cm is produced with a single injection of polypropylene reinforced with glass fiber obtained by means of the latest generation of air moulding technology with neutral tones. For indoor and outdoor use.

101 Ares Bar 75

CATAS
TEST REPORT
236235

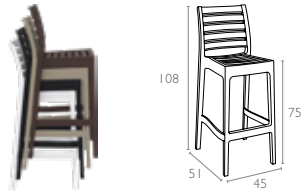

Colors



White

Black

Dark Grey

Brown

Taupe



Opera Bar 75



Stacking wedding bar stool h.75 cm for indoor and outdoor use in clear or shiny polycarbonate. Scratch resistant, UV - resistant.

073 Opera Bar 75

CATAS
TEST REPORT
226344

Made with
Makrolon®
The high-tech polycarbonate

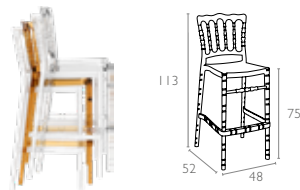

Colors



Glossy White Amber Transparent Clear Transparent



Opera Bar 65



Stacking wedding bar stool h.65 cm for indoor and outdoor use in clear or shiny polycarbonate. Scratch resistant, UV - resistant.

074 Opera Bar 65

CATAS
TEST REPORT
226344

Made with
Makrolon®
The high-tech polycarbonate

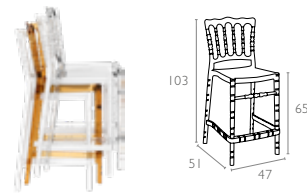

Colors



Glossy White

Amber Transparent

Clear Transparent



Chiavari Bar 75



Stacking wedding bar stool h.75 cm for indoor and outdoor use in clear or shiny polycarbonate. Scratch resistant, UV - resistant.

083 Chiavari Bar 75

CATAS
TEST REPORT
226346

Made with
Makrolon®
The high-tech polycarbonate

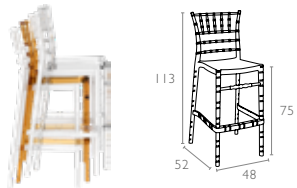

Colors



Glossy White

Amber Transparent

Clear Transparent



Chiavari Bar 65



Stacking wedding bar stool h.65 cm for indoor and outdoor use in clear or shiny polycarbonate. Scratch resistant, UV - resistant.

084 Chiavari Bar 65

CATAS
TEST REPORT
226346

Made with
Makrolon®
The high-tech polycarbonate

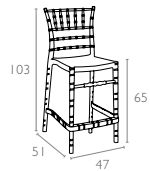

Colors



Glossy White

Amber Transparent

Clear Transparent





Stacking bar stool h.75 cm for indoor and outdoor use in shiny technopolymer PA6 nylon or clear polycarbonate. Scratch resistant, self - extinguish classification V2, UV - resistant.

037 Fox 75

CATAS
TEST REPORT
101129

Made with
Makrolon®
The high-tech polycarbonate



Colors

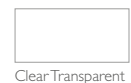
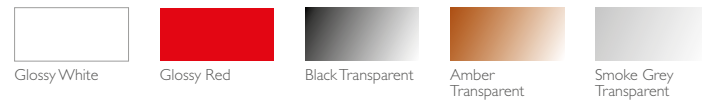

Clear Transparent



Fox 65



Stacking bar stool h.65 cm for indoor and outdoor use in shiny technopolymer PA6 nylon or clear polycarbonate. Scratch resistant, self - extinguish classification V2, UV - resistant.

036 Fox 65

CATAS
TEST REPORT
101129



Made with
Makrolon®
The high-tech polycarbonate

Colors



Air Bar 75



Air Bar stool h.75 cm is produced with a single injection of polypropylene reinforced with glass fiber obtained by means of the latest generation of air moulding technology with neutral tones. For indoor and outdoor use.

068 Air Bar 75

CATAS
TEST REPORT
184081

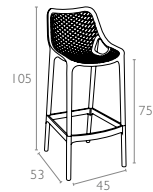

Colors





Air Bar stool h.65 cm is produced with a single injection of polypropylene reinforced with glass fiber obtained by means of the latest generation of air moulding technology with neutral tones. For indoor and outdoor use.

067 Air Bar 65

CATAS
TEST REPORT
184081

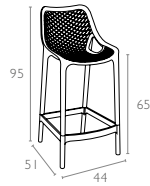

Colors



White

Black

Dark Grey

Red

Taupe



Tropical Green



Orange





Revolving stool with adjustable height with gas piston. Base and column in stainless steel. Seat in recyclable polycarbonate. For indoor use.

042 Aria

Made with **Makrolon**[®]
The high-tech polycarbonate

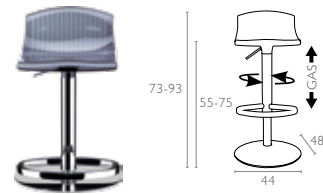

Colors



Glossy White Red Transparent Amber Transparent Black Transparent Clear Transparent



Gio 75



Stacking bar stool with recyclable polypropylene seat and backrest and square anodized aluminium legs. Diameter 25x25 mm. For indoor and outdoor use.

035 Gio 75

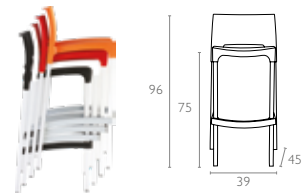

Colors



Black

Light Green

Orange

Red

Beige



White



Queen



Stacking side table for indoor and outdoor use in clear polycarbonate. UV - resistant.

065 Queen

Made with **Makrolon®**
The high-tech polycarbonate

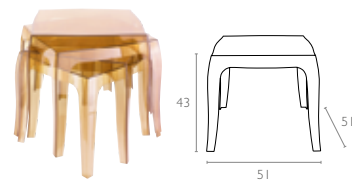

Colors

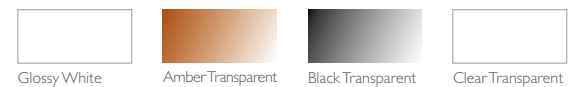

Glossy White Amber Transparent Black Transparent Clear Transparent



Sky Side Table



Sky Side Table is made of durable weather-resistant resin. Non-metallic frame will never unravel, rust or decay. It is UV protected which insures the colors will not fade. Can be disassembled. For indoor and outdoor use.

109 Sky Side Table

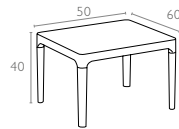

Colors



White

Black

Dark Grey

Taupe

Red



Yellow



Sky Lounge Table



Sky Table is made of durable weather-resistant resin. Metallic frame will never unravel, rust or decay. It is UV protected which insures the colors will not fade. Can be disassembled. For indoor and outdoor use.

104 Sky Lounge Table

CATAS
TEST REPORT
257118

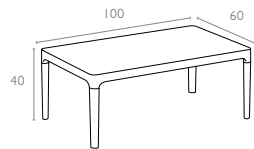

Colors



White

Black

Dark Grey

Taupe

Red



Yellow



Box Table



Stacking table in recyclable polypropylene.
For indoor and outdoor use.

064 Box Table

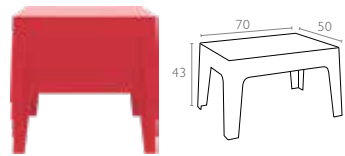

Colors



Black Red Silver Grey Dark Grey Tropical Green



Orange White



Ocean Side Table



Ocean Side Table is made of durable weather-resistant resin. Non-metallic frame will never unravel, rust or decay. It is UV protected which insures the colors will not fade. Can be disassembled. For indoor and outdoor use.

066 Ocean Side Table

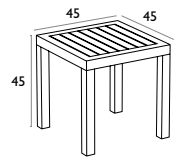

Colors



Black

Dark Grey

Silver Grey

Taupe

White



Ocean Table



Ocean Lounge Table is made of durable weather-resistant resin. Non-metallic frame will never unravel, rust or decay. It is UV protected which insures the colors will not fade. Can be disassembled. For indoor and outdoor use.

069 Ocean Table

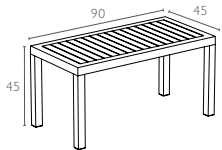

Colors



Vegas Table



Extendible table from 100 to 140 cm in polypropylene reinforced with glass fiber. Easily expandable, giving you a choice of two size options. Smart extending mechanism makes it easy to adjust the table to your preferred size. For indoor and outdoor use with UV protection.



772 Vegas Table

CATAS
TEST REPORT
253099

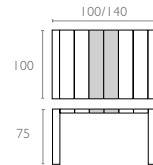

Colors



White

Black

Dark Grey

Taupe



Vegas Table Medium



Extendible table from 180 to 220 cm in polypropylene reinforced with glass fiber. Easily expandable, giving you a choice of two size options. Smart extending mechanism makes it easy to adjust the table to your preferred size. For indoor and outdoor use with UV protection.



774 Vegas Table Medium

CATAS
TEST REPORT
253098

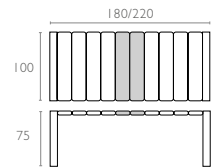

Colors



White

Black

Dark Grey

Taupe



Vegas Table XL



Extendible table from 260 to 300 cm in polypropylene reinforced with glass fiber. Easily expandable, giving you a choice of two size options. Smart extending mechanism makes it easy to adjust the table to your preferred size. For indoor and outdoor use with UV protection.



776 Vegas Table XL

CATAS
TEST REPORT
253097

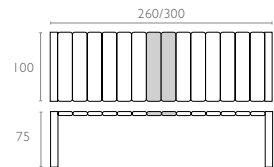

Colors



White Black Dark Grey Taupe



Vegas Bar 100



Extendible bar table from 100 to 140 cm in polypropylene reinforced with glass fiber. Easily expandable, giving you a choice of two size options. Smart extending mechanism makes it easy to adjust the bar table to your preferred size. For indoor and outdoor use with UV protection.



782 Vegas Bar 100

CATAS
TEST REPORT

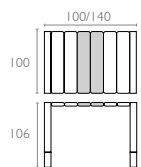

Colors



White

Black

Dark Grey

Taupe



Sky Folding Table 60



Sky folding table is made of durable weather-resistant resin. Metallic frame will never unravel, rust or decay. It is UV protected which insures the colors will not fade. Can be disassembled. For indoor and outdoor use.

114 Sky Folding Table 60



Colors



Sky Folding Table Ø60



Sky folding table is made of durable weather-resistant resin. Metallic frame will never unravel, rust or decay. It is UV protected which insures the colors will not fade. Can be disassembled. For indoor and outdoor use.

121 Sky Folding Table Ø60

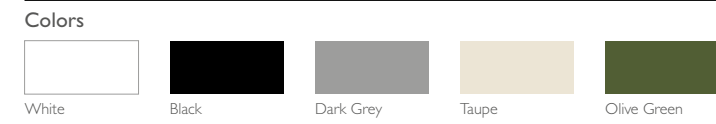

Sky Table 70



Sky Table is made of durable weather-resistant resin. Metallic frame will never unravel, rust or decay. It is UV protected which insures the colors will not fade. Can be disassembled. For indoor and outdoor use.

108 Sky Table 70

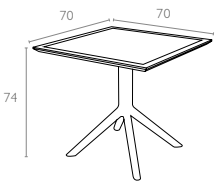

Colors



Sky Table 80



Sky Table is made of durable weather-resistant resin. Metallic frame will never unravel, rust or decay. It is UV protected which insures the colors will not fade. Can be disassembled. For indoor and outdoor use.

106 Sky Table 80

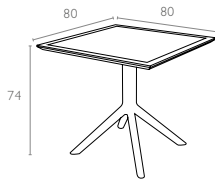

Colors



Air Table 80



Table with plastic legs with HPL compact laminated tops 12 mm available in white and black. For indoor and outdoor use. Can be disassembled.

** Dark colors not recommended in direct sunlight.*

700 Air Table 80

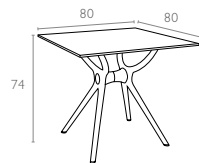

Colors



White



Black



Air Table I 40



Table with plastic legs with HPL compact laminated tops 12 mm available in white and black. For indoor and outdoor use. Can be disassembled.

** Dark colors not recommended in direct sunlight.*

705 Air Table I 40

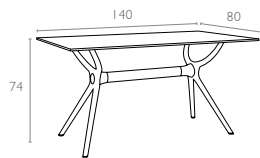

Colors



White



Black



Air Table 180



Table with plastic legs with HPL compact laminated tops 12 mm available in white and black. For indoor and outdoor use. Can be disassembled.

** Dark colors not recommended in direct sunlight.*

715 Air Table 180

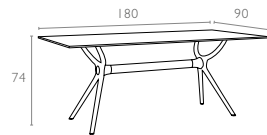

Colors



White



Black



Sky Folding Legs



Sky folding leg is made of durable weather-resistant resin. Metallic frame will never unravel, rust or decay. It is UV protected which insures the colors will not fade. Can be disassembled and suitable for werzalit or HPL compact tops. For indoor and outdoor use.

118 Sky Folding Legs

Top min: 50x50 cm
 Top max: 70x70 cm

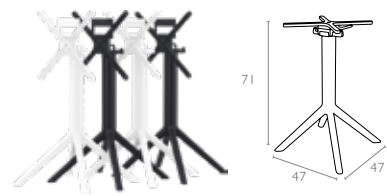

Colors



White

Black



Sky Legs



Sky leg is made of durable weather-resistant resin. Metallic frame will never unravel, rust or decay. It is UV protected which insures the colors will not fade. Can be disassembled and suitable for werzalit or HPL compact tops. For indoor and outdoor use.

107 Sky Legs

Top min : 70x70 cm
Top max : 90x90 cm

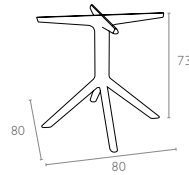

Colors



White

Black

Dark Grey

Taupe



Air Legs



335 Air Legs Small

*Top min. 70x70 cm, Top max. 90x90 cm

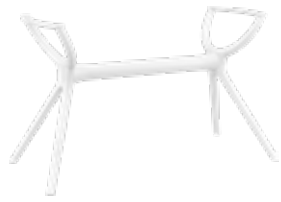
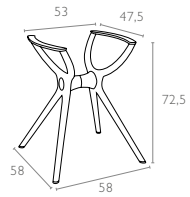

336 Air Legs Medium

*Top min. 70x120 cm, Top max. 80x160 cm

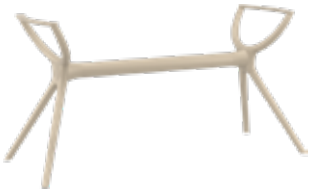
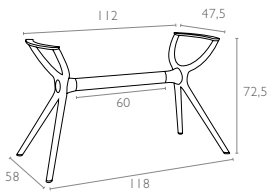

337 Air Legs XL

*Top min 90x180 cm, Top max 100x200 cm

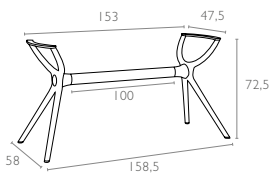

Air Legs are made up of polypropylene reinforced with glass fiber with the latest generation of air moulding thermoplastic injection. For indoor and outdoor use. Can be disassembled.

Colors



White

Black

Taupe



Octopus 60



Octopus table is made of durable weather-resistant resin. Metallic frame will never unravel, rust or decay. It is UV protected which insures the colors will not fade. Can be disassembled. For indoor and outdoor use.

160 Octopus 60



Colors



Yellow



Octopus Bar



Octopus Bar table is made of durable weather-resistant resin. Metallic frame will never unravel, rust or decay. It is UV protected which insures the colors will not fade. Can be disassembled. For indoor and outdoor use.

161 Octopus Bar



Colors



Black

Dark Grey

Taupe

White



Sky Folding Bar Table 60



Sky folding bar table is made of durable weather-resistant resin. Metallic frame will never unravel, rust or decay. It is UV protected which insures the colors will not fade. Can be disassembled. For indoor and outdoor use.

1 | 6 Sky Folding Bar Table 60

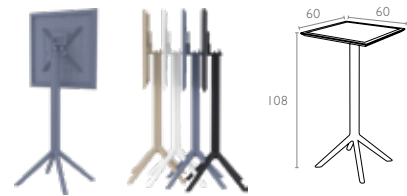

Colors



Sky Folding Bar Table Ø60



Sky folding bar table is made of durable weather-resistant resin. Metallic frame will never unravel, rust or decay. It is UV protected which insures the colors will not fade. Can be disassembled. For indoor and outdoor use.

122 Sky Folding Bar Table Ø60

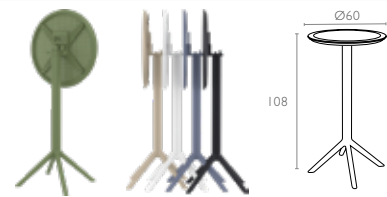

Colors



White Black Dark Grey Taupe Olive Green



Ares 80



Ares 80 table is made of durable weather-resistant resin. Non-metallic frame will never unravel, rust or decay. It is UV protected which insures the colors will not fade. Can be disassembled. For indoor and outdoor use.

164 Ares 80

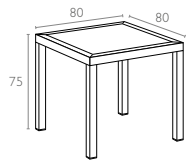

Colors

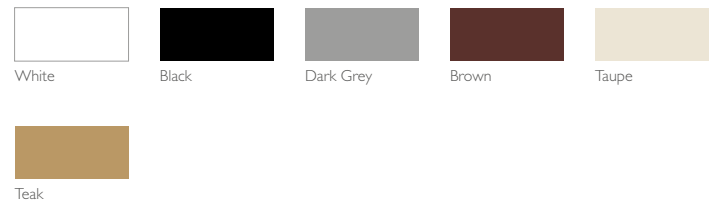

Ares 140



Ares 140 table is made of durable weather-resistant resin. Non-metallic frame will never unravel, rust or decay. It is UV protected which insures the colors will not fade. Can be disassembled. For indoor and outdoor use.

186 Ares 140

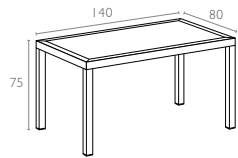

Colors

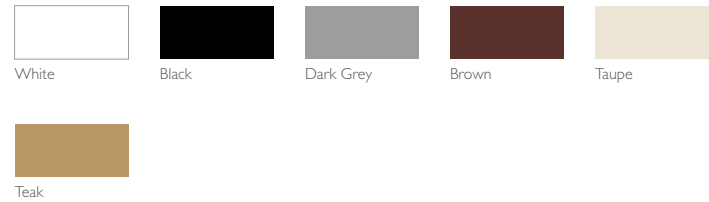



685 Maya 80

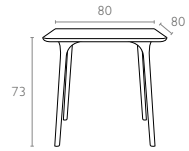

675 Maya 120



690 Maya 140

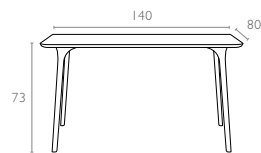

HPL compact laminated tops
12 mm with the latest generation of
air moulding thermoplastic legs.
For indoor and outdoor use.
Can be disassembled.

* Dark colors not recommended in direct sunlight.



Colors



White



Black









500 - 510 - 520 Ice

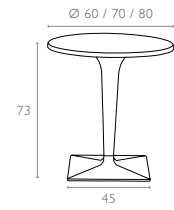

550 - 560 Ice

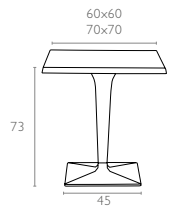

Table with clear transparent polycarbonate leg and painted aluminium base. Werzalit tops, resistant to outdoor use, available in white, black and silver grey. For indoor and outdoor use.



Colors



White



Black



Silver Grey





Ice Leg & Base



Clear transparent polycarbonate leg and painted aluminium base.
For indoor and outdoor use.

310 Ice Leg & Base

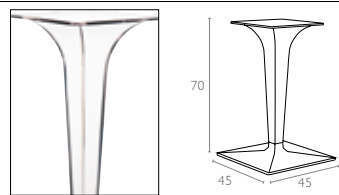

Made with
Makrolon[®]
The high-tech polycarbonate

Colors



Clear Transparent



Mango



Stacking table with the latest generation of air moulding thermoplastic injection. For indoor and outdoor use.

800 Mango

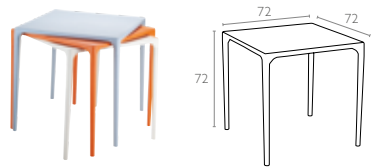

Colors



Mango Alu



Stacking table with the latest generation of air moulding thermoplastic injection with legs in anodized aluminium. For indoor and outdoor use.

758 Mango Alu

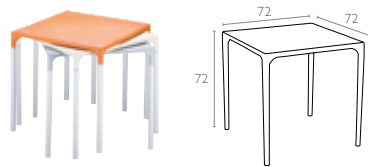

Colors



White

Beige

Orange

Silver Grey





Folding table with legs in anodized aluminium. Diameter 30 mm. Table top in recyclable polypropylene. For indoor and outdoor use.

770 Forza



Colors

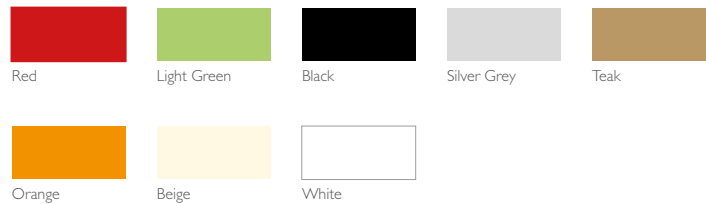

Sortie



Table top in recyclable polypropylene, anodized aluminium legs.
Diameter 25 mm. For indoor and outdoor use. Can be disassembled.

750 Sortie

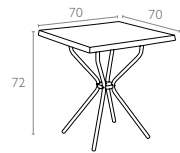

Colors



Black

Red

Light Green

Orange

Beige



White



Poppy 80



Table top in recyclable polypropylene, anodized aluminium legs.
Diameter 25 mm. For indoor and outdoor use. Can be disassembled.

720 Poppy 80

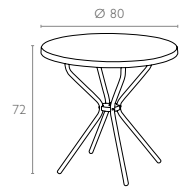

Colors



Black

Red

Light Green

Orange

Beige



White





Table top in recyclable polypropylene, anodized aluminium legs.
Diameter 25 mm. For indoor and outdoor use. Can be disassembled.

710 Elfo 70

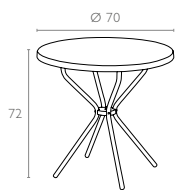

Colors



Black

Red

Light Green

Orange

Beige



White



Dodo



Suspension lamp in polycarbonate with 25W energy saving lamp. The diffuser can be removed without dismantling the electrical body, for an easy fitting and removal.

415 Dodo



Made with **Makrolon**[®]
The high-tech polycarbonate

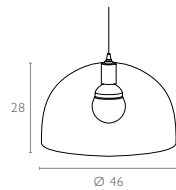

Colors

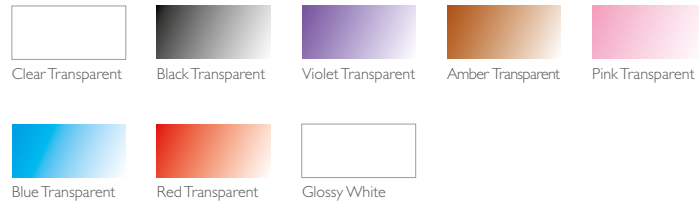



Suspension lamp in polycarbonate with 25W energy saving lamp. The diffuser can be removed without dismantling the electrical body, for an easy fitting and removal.

410 Nova

CE

Made with
Makrolon®
The high-tech polycarbonate

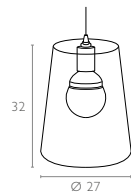

Colors



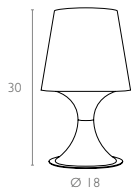

Table lamp made of transparent or coloured injected polycarbonate, with 40W lamp. Perfect gift idea.

420 Smart



Made with **Makrolon**[®]
The high-tech polycarbonate



Colors

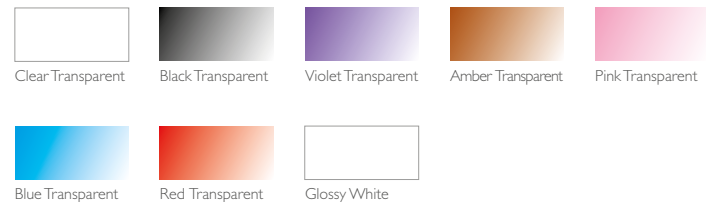

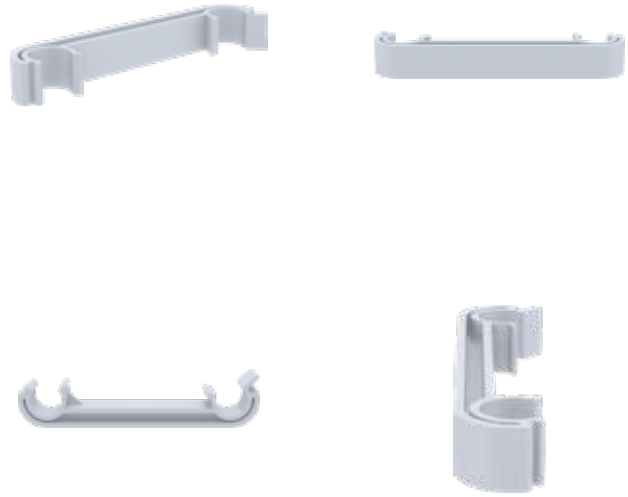

Link linking device in polypropylene to be fixed on the frame.
Suitable for all round legs \varnothing 25mm.

097 Link

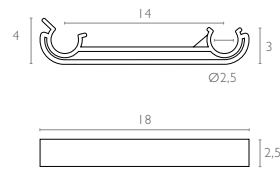

Colors



Silver Grey



Artemis XL Cushions



5 cm thick seat and backrest cushion covered with polyester fabric and finished with piping. Cushion is specially designed for Artemis XL armchair.

899 Artemis XL Seat Cushion

900 Artemis XL Backrest Cushion

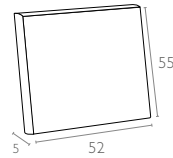
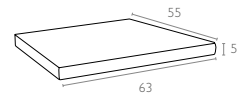

Cushion Colors

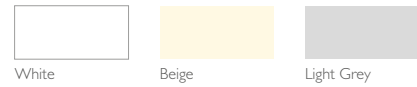

White Beige Light Grey



Mykonos Cushions



10 cm thick cushion covered with Etisilk polyester fabric and finished with piping. Cushions are specially designed for Mykonos Lounge Set. Water resistant with UV.



141 Mykonos Seat Cushion

142 Mykonos Backrest Cushion

143 Mykonos Corner Cushion

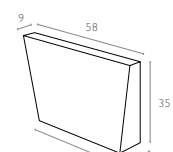
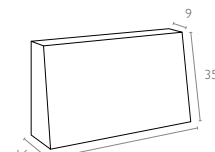
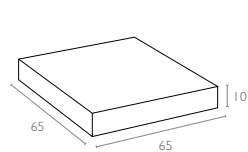

Cushion Colors



Beige Light Brown Dark Grey Black



Slim Cushions

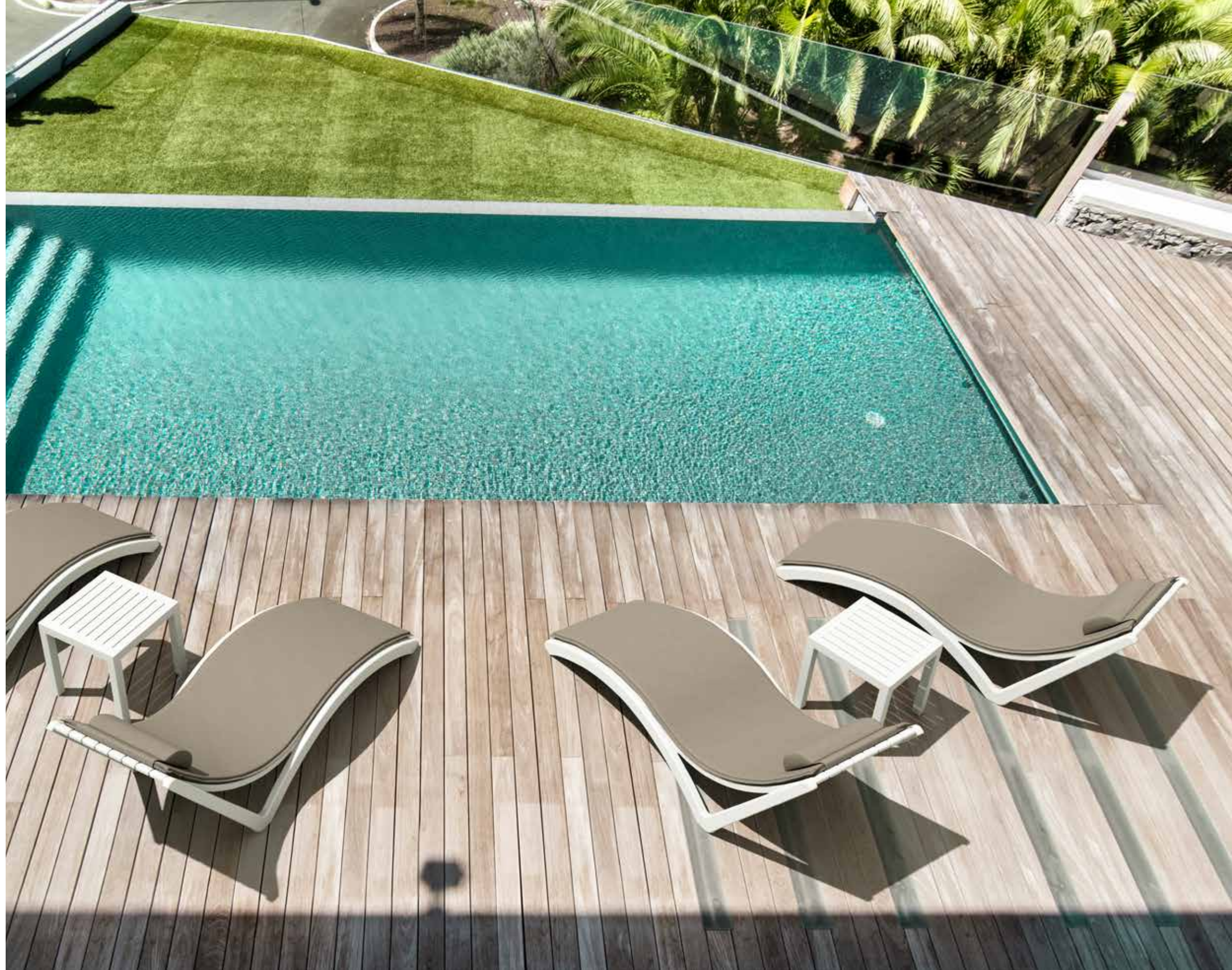

3 cm thick Slim cushion and 5 cm thick Slim pillow cushion covered with Etisilk polyester fabric and finished with piping. Cushions are specially designed for Slim sunlounger Water resistant with UV.



144 Slim Cushion

148 Slim Pillow Cushion

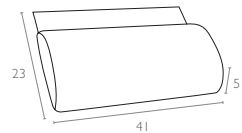
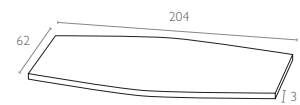

Cushion Colors



White Light Brown Dark Grey Black

232 PACIFIC LOUNGE ARMCHAIR

Pacific stacking lounge armchair with Batyline fabric from Serge Ferrari is made from a weather-proof, UV-protected resin reinforced by glass fiber that stands up to summer showers and strong sun, making it the ideal, worry-free addition to your outdoor seating area. For domestic or commercial use.



White
White



Dark Grey
Black



Black
Black



Taupe
Taupe

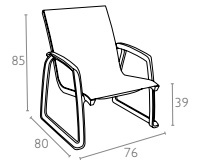

231 PACIFIC LOUNGE CHAIR

Pacific stacking lounge chair with Batyline fabric from Serge Ferrari is made from a weather-proof, UV-protected resin reinforced by glass fiber that stands up to summer showers and strong sun, making it the ideal, worry-free addition to your outdoor seating area. For domestic or commercial use.



White
White



Dark Grey
Black



Black
Black



Taupe
Taupe

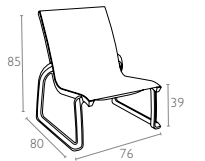

023 PACIFIC ARMCHAIR

Pacific armchair with Batyline fabric from Serge Ferrari is made from a weather-proof, UV-protected resin reinforced by glass fiber that stands up to summer showers and strong sun, making it the ideal, worry-free addition to your outdoor seating area. This versatile armchair pairs perfectly with the Pacific sunlounger, as well as a wide range of other outdoor tables. For domestic or commercial use.



White
White



Dark Grey
Black



Black
Black



Taupe
Taupe

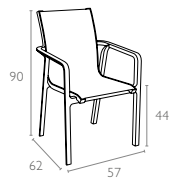

151 SKY PRO

Sky Pro stacking armchair is produced with a single injection of polypropylene reinforced with glass fiber obtained by means of the latest generation of air moulding technology with neutral tones. For indoor and outdoor use.



White



Dark Grey



Black



Taupe



Olive Green

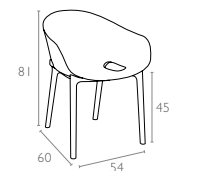

102 SKY

Sky armchair is produced with recyclable polypropylene seat and legs reinforced with glass fiber. For indoor and outdoor use. Can be disassembled.



White



Dark Grey



Black



Taupe



Red



Yellow

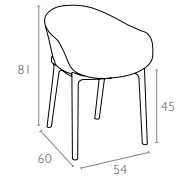

CATAS
TEST REPORT
261210



103 SKY LOUNGE

Sky lounge chair is produced with recyclable polypropylene seat and legs reinforced with glass fiber. For indoor and outdoor use. Can be disassembled.



White



Dark Grey



Black



Taupe



Red



Yellow

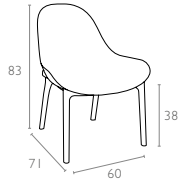

CATAS
TEST REPORT
257287



251 MARIE

Marie stacking chair is produced with a single injection of polypropylene reinforced with glass fiber obtained by means of the latest generation of air moulding technology with neutral tones. For indoor and outdoor use.



White



Black



Olive Green

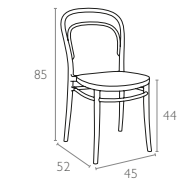

CATAS
TEST REPORT
294904



252 VICTOR

Victor stacking chair is produced with a single injection of polypropylene reinforced with glass fiber obtained by means of the latest generation of air moulding technology with neutral tones. For indoor and outdoor use.



White



Dark Grey



Black



Taupe



Olive Green

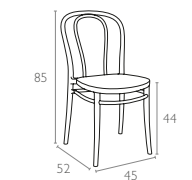

CATAS
TEST REPORT
294905



253 VICTOR XL

Victor XL stacking armchair is produced with a single injection of polypropylene reinforced with glass fiber obtained by means of the latest generation of air moulding technology with neutral tones. For indoor and outdoor use.

CATAS
TEST REPORT
294886



White



Dark Grey



Black



Taupe



Olive Green

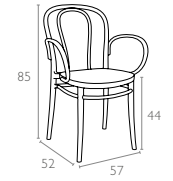

254 CROSS

Cross stacking chair is produced with a single injection of polypropylene reinforced with glass fiber obtained by means of the latest generation of air moulding technology with neutral tones. For indoor and outdoor use.

CATAS
TEST REPORT
294906



White



Dark Grey



Black



Taupe



Olive Green

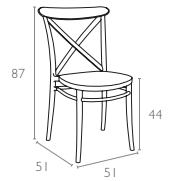

256 CROSS XL

Cross XL stacking armchair is produced with a single injection of polypropylene reinforced with glass fiber obtained by means of the latest generation of air moulding technology with neutral tones. For indoor and outdoor use.

CATAS
TEST REPORT
294885



White



Dark Grey



Black



Taupe



Olive Green

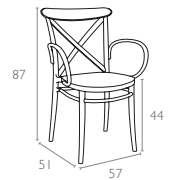

257 MARCEL

Marcel stacking chair is produced with a single injection of polypropylene reinforced with glass fiber obtained by means of the latest generation of air moulding technology with neutral tones. For indoor and outdoor use.

CATAS
TEST REPORT
294903



White



Dark Grey



Black



Taupe



Olive Green

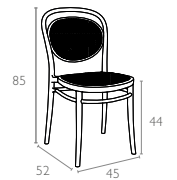

258 MARCEL XL

Marcel XL stacking armchair is produced with a single injection of polypropylene reinforced with glass fiber obtained by means of the latest generation of air moulding technology with neutral tones. For indoor and outdoor use.

CATAS
TEST REPORT
294887



White



Dark Grey



Black



Taupe



Olive Green

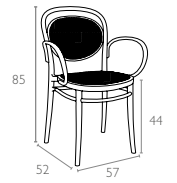

079 DREAM

Dream folding chair is produced with a single injection of polypropylene reinforced with glass fiber obtained by means of the latest generation of air moulding technology with neutral tones. For indoor and outdoor use.

CATAS
TEST REPORT
294880



White



Dark Grey



Black



Taupe



Red



Olive Green

designed by
Frédéric Boonen
bds

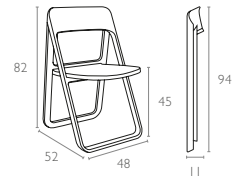

127 MONNA

Monna chair is produced with a single injection of polypropylene reinforced with glass fiber obtained by means of the latest generation of air moulding technology with neutral tones. For indoor and outdoor use.

CATAS
TEST REPORT
276554



White



Dark Grey



Black



Taupe



Red



Olive Green

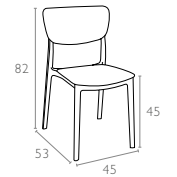

126 LISA

Lisa armchair is produced with a single injection of polypropylene reinforced with glass fiber obtained by means of the latest generation of air moulding technology with neutral tones. For indoor and outdoor use.

CATAS
TEST REPORT
276570



White



Dark Grey



Black



Taupe



Red



Olive Green

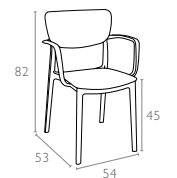

129 LUCY

Lucy chair is produced with a single injection of polypropylene reinforced with glass fiber obtained by means of the latest generation of air moulding technology with neutral tones. For indoor and outdoor use.

CATAS
TEST REPORT
276562



White



Dark Grey



Black



Taupe



Olive Green

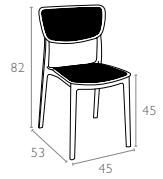

128 LOFT

Loft armchair is produced with a single injection of polypropylene reinforced with glass fiber obtained by means of the latest generation of air moulding technology with neutral tones. For indoor and outdoor use.

CATAS
TEST REPORT
276563



White



Dark Grey



Black



Taupe



Olive Green

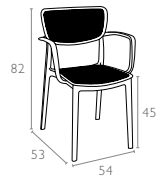

085 MILA

Mila armchair is produced with a single injection of polypropylene reinforced with glass fiber obtained by means of the latest generation of air moulding technology with neutral tones. For indoor and outdoor use.

CATAS
TEST REPORT
233341



White



Dark Grey



Black



Taupe



Red



Yellow

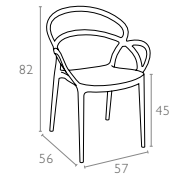

086 PIA

Pia chair is produced with a single injection of polypropylene reinforced with glass fiber obtained by means of the latest generation of air moulding technology with neutral tones. For indoor and outdoor use.

CATAS
TEST REPORT
233342



White



Dark Grey



Black



Taupe



Red



Yellow

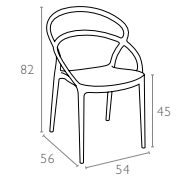

088 SUNSET

Sunset chair is produced with a single injection of polypropylene reinforced with glass fiber obtained by means of the latest generation of air moulding technology with neutral tones. For indoor and outdoor use.



White



Dark Grey



Black



Brown



Taupe

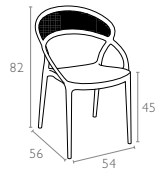

093 PLUS

Plus armchair is produced with a single injection of polypropylene reinforced with glass fiber obtained by means of the latest generation of air moulding technology with neutral tones. For indoor and outdoor use.



White



Black



Red

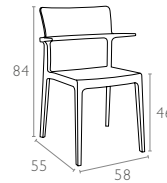

092 SNOW

Snow chair is produced with a single injection of polypropylene reinforced with glass fiber obtained by means of the latest generation of air moulding technology with neutral tones. For indoor and outdoor use.



White



Dark Grey



Black



Taupe



Red



Yellow



Olive Green

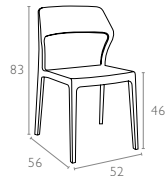

090 MOON

Stacking chair with the latest generation of air moulding thermoplastic injection. Seat in polypropylene reinforced with glass fiber; backrest in transparent polycarbonate. For indoor and outdoor use.

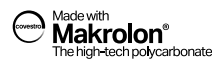

White Glossy White



White Amber Transparent



White Red Transparent



White Clear Transparent



Black Clear Transparent



Black Black Transparent



Black Amber Transparent



Black Red Transparent

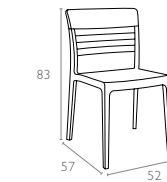

091 FLASH

Stacking chair with the latest generation of air moulding thermoplastic injection. Seat in polypropylene reinforced with glass fiber, backrest in transparent polycarbonate. For indoor and outdoor use.



White Glossy White White Amber Transparent White Red Transparent White Clear Transparent Black Clear Transparent



Black Black Transparent Black Amber Transparent Black Red Transparent

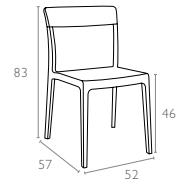

048 BLOOM

Bloom chair is produced with a single injection of polypropylene reinforced with glass fiber obtained by means of the latest generation of air moulding technology with neutral tones. For indoor and outdoor use.



White Dark Grey Silver Grey Black Taupe Red Yellow

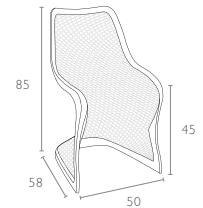

007 AIR XL

Air XL armchair is produced with a single injection of polypropylene reinforced with glass fiber obtained by means of the latest generation of air moulding technology with neutral tones. For indoor and outdoor use.



White Orange Dark Grey Black Taupe Red Tropical Green Yellow

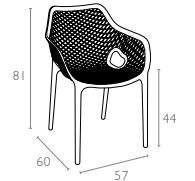

014 AIR

Air chair is produced with a single injection of polypropylene reinforced with glass fiber obtained by means of the latest generation of air moulding technology with neutral tones. For indoor and outdoor use.



White Orange Dark Grey Black Taupe Red Tropical Green Yellow

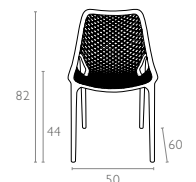

039 MIRANDA

Miranda chair is produced with a single injection of polypropylene reinforced with glass fiber obtained by means of the latest generation of air moulding technology with neutral tones. For indoor and outdoor use.



White



Dark Grey



Black



Brown



Taupe

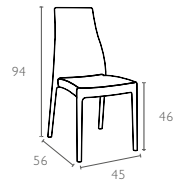

054 SOHO

Soho chair is produced with a single injection of polypropylene reinforced with glass fiber obtained by means of the latest generation of air moulding technology with neutral tones. For indoor and outdoor use.



White



Dark Grey



Black



Brown



Taupe



Red

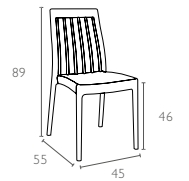

050 JOSEPHINE

Josephine wedding chair is produced with a single injection of polypropylene reinforced with glass fiber obtained by means of the latest generation of air moulding technology with neutral tones. For indoor and outdoor use.



White



Black

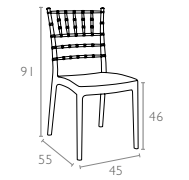

044 NAPOLEON

Napoleon wedding chair is produced with a single injection of polypropylene reinforced with glass fiber obtained by means of the latest generation of air moulding technology with neutral tones. For indoor and outdoor use.



White



Silver Grey



Black



Gold

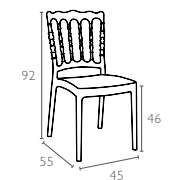

061 OPERA

Stacking wedding chair for indoor and outdoor use in clear or shiny polycarbonate. Scratch resistant, UV - resistant.



Glossy White

Amber Transparent

Clear Transparent

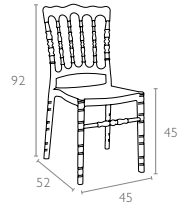
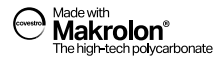

071 CHIAVARI

Stacking wedding chair for indoor and outdoor use in clear or shiny polycarbonate. Scratch resistant, UV - resistant.



Glossy White

Amber Transparent

Clear Transparent

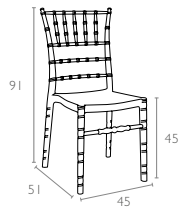
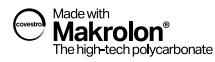

052 CRYSTAL

Stacking armchair for indoor and outdoor use in clear polycarbonate moulded with gas technology of the second generation. Scratch resistant, UV - resistant.



Glossy White

Clear Transparent

Smoke Grey Transparent

Black Transparent

Orange Transparent

Amber Transparent

Red Transparent

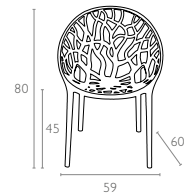
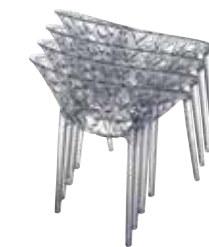

034 ELIZABETH

Stacking chair for indoor and outdoor use in shiny technopolymer PA6 nylon or clear polycarbonate. Scratch resistant, self - extinguish classification V2, UV - resistant.



Glossy White

Glossy Red

Glossy Black

Clear Transparent

Black Transparent

Amber Transparent

Pink Transparent

* Black Transparent

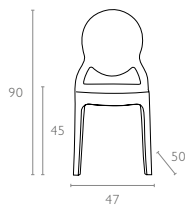

* On request with cushion.

051 BABY ELIZABETH

Stacking children chair Baby Elizabeth for indoor and outdoor use in clear polycarbonate. Scratch resistant, UV – resistant.

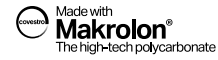

Glossy White



Clear Transparent



Pink Transparent



Violet Transparent



Red Transparent



Blue Transparent

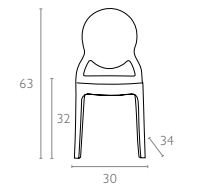

053 ARTHUR

Stacking armchair for indoor and outdoor use in shiny technopolymer PA6 nylon or clear polycarbonate. Scratch resistant, self - extinguish classification V2, UV - resistant.



Glossy White



Glossy Red



Glossy Black



Clear Transparent



Black Transparent



Amber Transparent

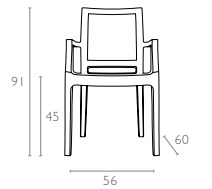

005 BO

Stacking chair for indoor and outdoor use in clear or shiny polycarbonate. Scratch resistant, UV - resistant.

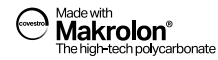

Glossy White



Glossy Black



Clear Transparent

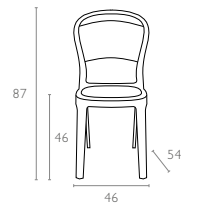

021 BEE

Stacking chair for indoor and outdoor use in clear or shiny polycarbonate. Scratch resistant, UV - resistant.



Glossy White



Glossy Black



Clear Transparent



Black Transparent



Amber Transparent



Red Transparent

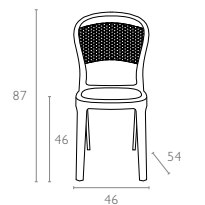

055 Miss BIBI

Stacking chair with the latest generation of air moulding thermoplastic injection. Seat in polypropylene reinforced with glass fiber; backrest in transparent polycarbonate. For indoor and outdoor use.



White Clear Transparent White Amber Transparent White Black Transparent White Red Transparent White Violet Transparent



Dark Grey Clear Transparent Dark Grey Smoke Grey Transparent Black Clear Transparent Black Amber Transparent Black Black Transparent

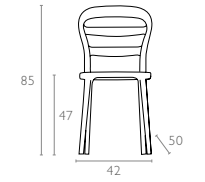

056 Mr BOBO

Stacking chair with the latest generation of air moulding thermoplastic injection. Seat in polypropylene reinforced with glass fiber; backrest in transparent polycarbonate. For indoor and outdoor use.

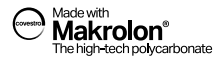

White Clear Transparent White Amber Transparent White Black Transparent Dark Grey Clear Transparent Dark Grey Smoke Grey Transparent



Black Clear Transparent Black Black Transparent

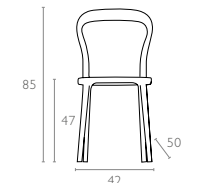

059 CARMEN

Stacking armchair with the latest generation of air moulding thermoplastic injection. Seat in polypropylene reinforced with glass fiber; backrest in transparent polycarbonate. For indoor and outdoor use.



White Glossy White White Clear Transparent White Amber Transparent White Black Transparent White Red Transparent



White Violet Transparent Black Clear Transparent Black Black Transparent Black Amber Transparent

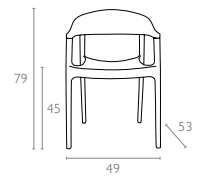

057 ALLEGRA

Recyclable polycarbonate main body. Legs frame in tubular chrome steel. Stackable. For indoor use.



Glossy White Clear Transparent Black Transparent Amber Transparent Red Transparent

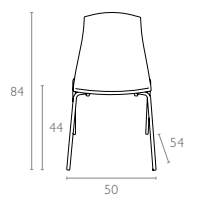

096 ALLEGRA-PP

Recyclable polycarbonate main body.
Legs frame in polypropylene.
For indoor and outdoor use.
Can be disassembled.



White
Glossy White



Black
Black Transparent



Brown
Glossy White

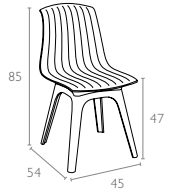

094 MIO-PP

Mio-PP chair is produced with
recyclable polypropylene seat and
legs reinforced with glass fiber.
For indoor and outdoor use.
Can be disassembled.



White
White



Black
Black



Brown
White

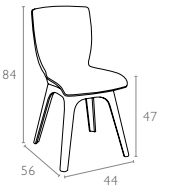

046 MIO

Stacking chair with recyclable
polypropylene seat and backrest and
painted steel legs. For indoor use.



White



Beige



Red



Orange



Black

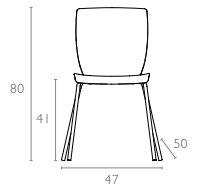

025 MAYA

Stacking chair with the latest
generation of air moulding
thermoplastic injection.
For indoor and outdoor use.



White



Orange



Silver Grey



Black



Light Blue



Dark Grey



Tropical Green



Olive Green

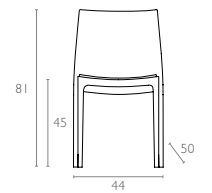

028 DIVA

Diva armchair is produced with a single injection of polypropylene reinforced with glass fiber obtained by means of the latest generation of air moulding technology with neutral tones. For indoor and outdoor use.



White



Orange



Silver Grey



Black



Light Blue



Dark Grey



Red



Tropical Green

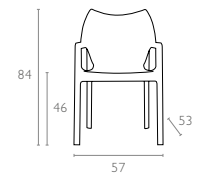

058 BOX

Recyclable polypropylene stacking armchair, strong and stable. Suitable for outdoor contract use.



White



Silver Grey



Dark Grey



Black



Red



Orange



Tropical Green

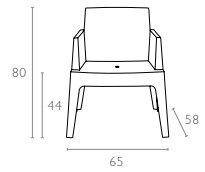

063 BOX SOFA

Recyclable polypropylene stackable sofa, very sturdy and stable. Suitable for outdoor contract use.



White



Silver Grey



Dark Grey



Black



Red



Orange



Tropical Green

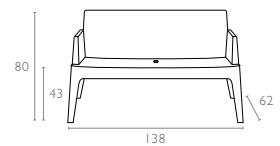

009 ARES

Ares chair is produced with a single injection of polypropylene reinforced with glass fiber obtained by means of the latest generation of air moulding technology with neutral tones. For indoor and outdoor use.



White



Taupe



Teak



Brown



Silver Grey



Dark Grey



Black

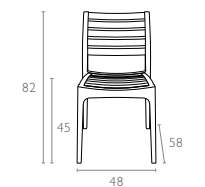

011 ARTEMIS

Artemis armchair is produced with a single injection of polypropylene reinforced with glass fiber obtained by means of the latest generation of air moulding technology with neutral tones. For indoor and outdoor use.

CATAS
TEST REPORT
163636



White



Taupe



Teak



Brown



Silver Grey



Dark Grey



Black

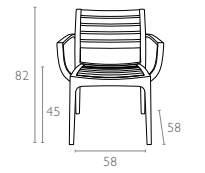

004 ARTEMIS XL

Artemis XL Lounge armchair is stackable and produced with a single injection of polypropylene reinforced with glass fiber, for indoor and outdoor use with or without cushion and non-slip feet. The Artemis collection also includes a coffee table, in various sizes, designed to match the styling silhouette of the chair to perfection.

CATAS
TEST REPORT
184080



White



Taupe



Silver Grey



Dark Grey



Black

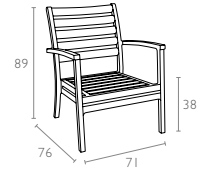

018 TIFFANY

Tiffany chair is produced with a single injection of polypropylene reinforced with glass fiber obtained by means of the latest generation of air moulding technology with neutral tones. Stackable. For indoor and outdoor use.

CATAS
TEST REPORT
135690



White



Orange



Silver Grey



Black



Light Blue



Dark Grey



Brown



Tropical Green

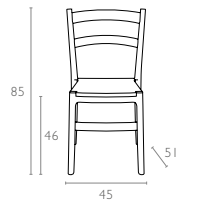

019 TIFFANY-S

Tiffany-S chair is produced with a single injection of polypropylene reinforced with glass fiber obtained by means of the latest generation of air moulding technology with neutral tones. Stackable. For indoor and outdoor use.

CATAS
TEST REPORT
135690



White



Light Blue



Dark Grey



Brown

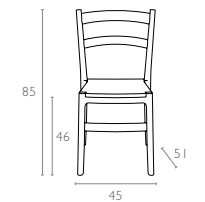

026 LUCCA

Stacking chair with the latest generation of air moulding thermoplastic injection. For indoor and outdoor use.

CATAS
TEST REPORT
85006



White



Orange



Silver Grey



Light Blue



Dark Grey



Tropical Green

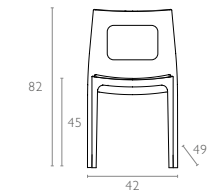

029 LUCCA-T

Stacking chair with the latest generation of air moulding thermoplastic injection. Back in transparent polycarbonate. For indoor and outdoor use.

Made with
Makrolon®
The high-tech polycarbonate



White



Orange



Light Blue

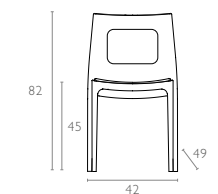

047 DOLCE

Stacking armchair with recyclable polypropylene seat and backrest and anodized aluminium legs. Diameter 25 mm. For indoor and outdoor use.



White



Beige



Red



Orange



Light Green



Dark Grey



Black

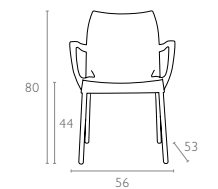

049 VITA

Stacking chair with recyclable polypropylene seat and backrest and anodized aluminium legs. Diameter 25 mm. For indoor and outdoor use.



White



Beige



Red



Orange



Light Green



Dark Grey



Black

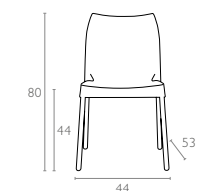

043 ROMEO

Stacking armchair with recyclable polypropylene seat and backrest and anodized aluminium legs. Diameter 25 mm. For indoor and outdoor use.



White



Beige



Red



Orange



Light Green



Black

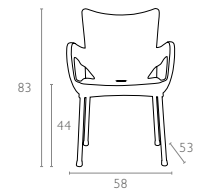

Blue

**045 JULIETTE**

Stacking chair with recyclable polypropylene seat and backrest and anodized aluminium legs. Diameter 25 mm. For indoor and outdoor use.



White



Beige



Red



Orange



Light Green



Black

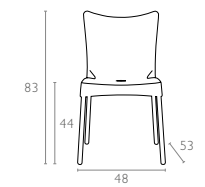

Blue

**041 GALA**

Stacking armchair in anodized aluminium with seat and back in recyclable polypropylene with latest generation of air moulding thermoplastic injection. Diameter 25 mm. For indoor and outdoor use.



White



Orange



Teak

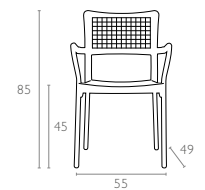

CATAS
TEST REPORT
79261

040 BELLA

Stacking armchair in anodized aluminium with seat and back in recyclable polypropylene with latest generation of air moulding thermoplastic injection. Diameter 25 mm. For indoor and outdoor use.



White



Orange



Teak

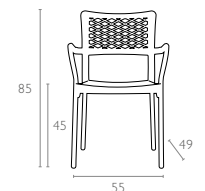

CATAS
TEST REPORT
79261

238 PACIFIC LOUNGE SET WITH ARMS

Pacific Lounge Set with arms is designed for easy self assembly, it is made of durable weather-resistant resin reinforced with glass fiber with Batyline fabric from Serge Ferrari. Non-metallic frame will never unravel, rust or decay. It is UV protected which insures the colors will not fade. For indoor and outdoor use. Can be purchased as set or separately.



White / White



Taupe / Taupe



Black / Black

Pacific Lounge Armchair
2 pcs

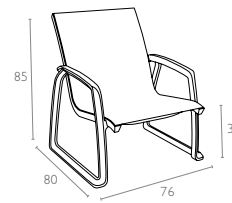

Pacific Lounge Sofa Armchair
1 pcs

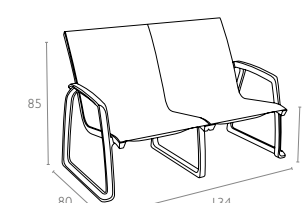

Sky Lounge Table
1 pcs

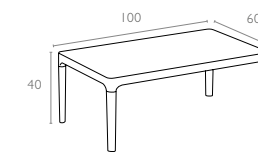

237 PACIFIC LOUNGE SET WITHOUT ARMS

Pacific Lounge Set without arms is designed for easy self assembly, it is made of durable weather-resistant resin reinforced with glass fiber with Batyline fabric from Serge Ferrari. Non-metallic frame will never unravel, rust or decay. It is UV protected which insures the colors will not fade. For indoor and outdoor use. Can be purchased as set or separately.



White / White



Taupe / Taupe



Black / Black

Pacific Lounge Chair
2 pcs

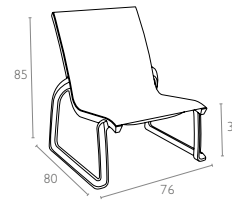

Pacific Lounge Sofa Chair
1 pcs

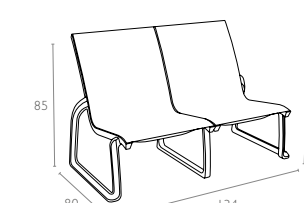

Sky Lounge Table
1 pcs

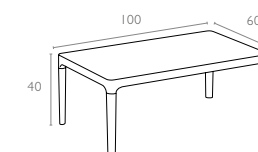

236 PACIFIC LOUNGE EXTENSION PART

With the Pacific Lounge extension part you can add as many seats as you want to extend your Pacific Lounge Sofa with Batyline fabric from Serge Ferrari.



White
White

Black
Black

Taupe
Taupe

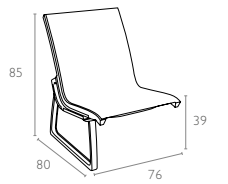

234 PACIFIC LOUNGE SOFA ARMCHAIR

Pacific Lounge sofa with arms designed for easy self assembly with Batyline fabric from Serge Ferrari is made from a weather-proof, UV-protected resin reinforced by glass fiber that stands up to summer showers and strong sun, making it the ideal, worry-free addition to your outdoor seating area. For domestic or commercial use.



White
White

Black
Black

Taupe
Taupe

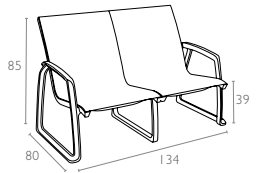

233 PACIFIC LOUNGE SOFA CHAIR

Pacific Lounge sofa without arms designed for easy self assembly with Batyline fabric from Serge Ferrari is made from a weather-proof, UV-protected resin reinforced by glass fiber that stands up to summer showers and strong sun, making it the ideal, worry-free addition to your outdoor seating area. For domestic or commercial use.



White
White

Black
Black

Taupe
Taupe

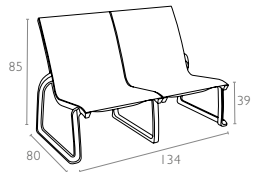

133 MYKONOS LOUNGE SET XL

Mykonos Lounge Set XL is designed for easy self assembly, it is made of durable weather-resistant resin reinforced with glass fiber. Non-metallic frame will never unravel, rust or decay. It is UV protected which insures the colors will not fade. Can be disassembled. For indoor and outdoor contract use.



White



Silver Grey



Taupe

Mykonos Lounge Armchair
2 pcs

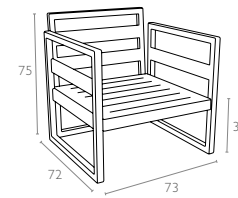

Mykonos Lounge Sofa XL
1 pcs

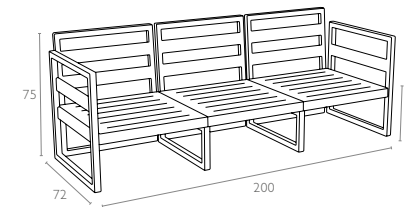

Mykonos Lounge Table XL
1 pcs

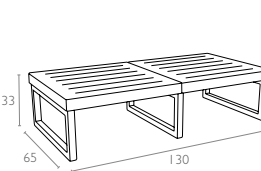

Mykonos Seat Cushion
5 pcs

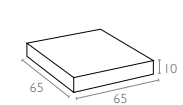

Mykonos Backrest Cushion
5 pcs

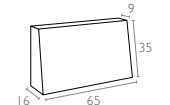

* Can be purchased with or without cushions.



132 MYKONOS LOUNGE SET

Mykonos Lounge Set is designed for easy self assembly, it is made of durable weather-resistant resin reinforced with glass fiber. Non-metallic frame will never unravel, rust or decay. It is UV protected which insures the colors will not fade. Can be disassembled. For indoor and outdoor contract use.



White



Silver Grey



Taupe

Mykonos Lounge Armchair
2 pcs

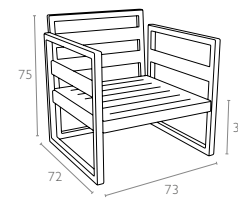

Mykonos Lounge Sofa
1 pcs

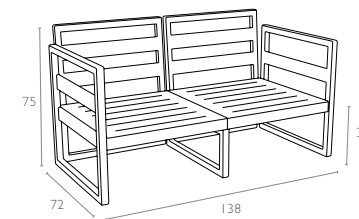

Mykonos Lounge Table
1 pcs

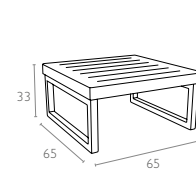

Mykonos Seat Cushion
4 pcs

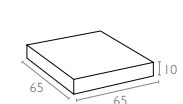

Mykonos Backrest Cushion
4 pcs

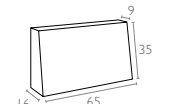

* Can be purchased with or without cushions.



134 MYKONOS LOUNGE CORNER SET

Mykonos Lounge Corner Set is designed for easy self assembly, it is made of durable weather-resistant resin reinforced with glass fiber. Non-metallic frame will never unravel, rust or decay. It is UV protected which insures the colors will not fade. Can be disassembled. For indoor and outdoor contract use.



White



Taupe



Silver Grey



Mykonos Lounge Corner
1 pcs

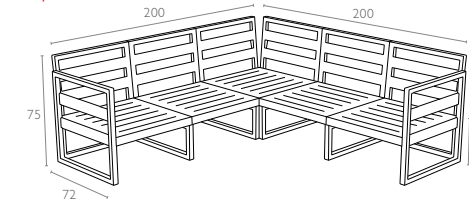

Mykonos Lounge Table
1 pcs

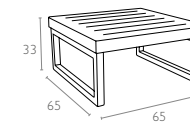

Mykonos Seat Cushion
5 pcs

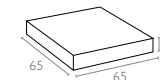

Mykonos Backrest Cushion
5 pcs

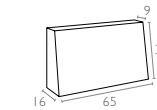

Mykonos Corner Cushion
1 pcs

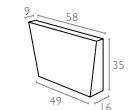

* Can be purchased with or without cushions.



131 MYKONOS LOUNGE ARMCHAIR

Mykonos Lounge Armchair is designed for easy self assembly, it is made of durable weather-resistant resin reinforced with glass fiber. Non-metallic frame will never unravel, rust or decay. It is UV protected which insures the colors will not fade. Can be disassembled. For indoor and outdoor contract use.



White



Taupe



Silver Grey

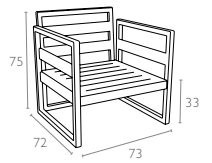

137 MYKONOS LOUNGE TABLE

Mykonos Lounge Table is made of durable weather-resistant resin. Non-metallic frame will never unravel, rust or decay. It is UV protected which insures the colors will not fade. Can be disassembled. For indoor and outdoor use.



White



Taupe



Silver Grey

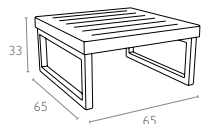

138 MYKONOS LOUNGE TABLE XL

Mykonos Lounge Table XL is made of durable weather-resistant resin. Non-metallic frame will never unravel, rust or decay. It is UV protected which insures the colors will not fade. Can be disassembled. For indoor and outdoor use.



White

Taupe

Silver Grey

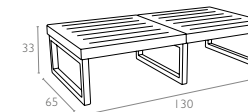

136 MYKONOS EXTENSION PART

With the extension part you can add as many seats as you want to extend your corner set.



White

Taupe

Silver Grey

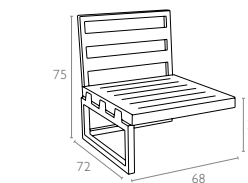

087 SLIM

Slim sunlounger is stackable and comes with hidden wheels and anti-slippery rubbers. It is made of durable weather-resistant resin. Non metallic frame will never unravel, rust or decay. It is UV protected which insures the colors will not fade. For outdoor use.

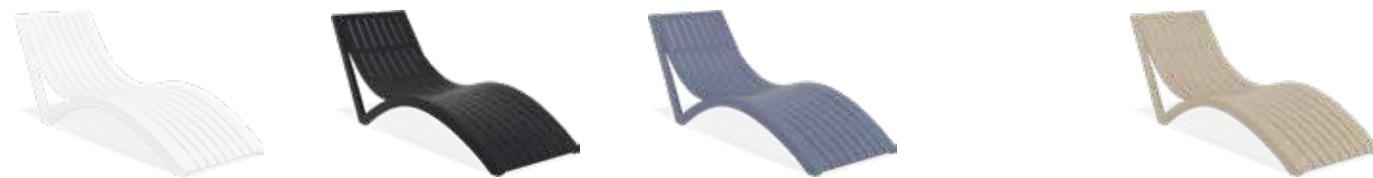

White

Black

Dark Grey

Taupe

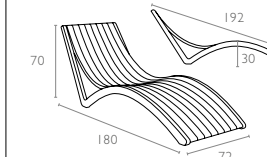

089 PACIFIC

Sunlounger without arms, tubular frame in resin reinforced with glass fiber and cover in breathable synthetic fabric (replaceable). Stackable, back reclining in 5 positions, with non-slip feet and small wheels.



White
White

White
Taupe

White
Turquoise

White
Blue

Dark Grey
Black

Black
Black

Taupe
Taupe

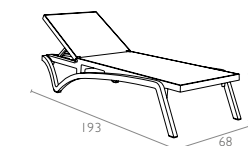

262 VICTOR BAR 75

Victor bar stool h.75 cm is produced with a single injection of polypropylene reinforced with glass fiber obtained by means of the latest generation of air moulding technology with neutral tones. For indoor and outdoor use.



White



Dark Grey



Black



Taupe



Olive Green

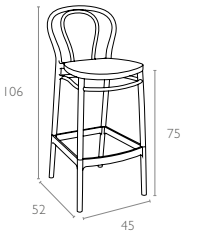

261 VICTOR BAR 65

Victor bar stool h.65 cm is produced with a single injection of polypropylene reinforced with glass fiber obtained by means of the latest generation of air moulding technology with neutral tones. For indoor and outdoor use.



White



Dark Grey



Black



Taupe



Olive Green

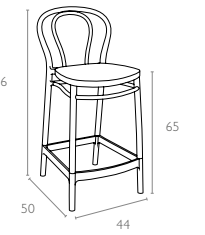

266 CROSS BAR 75

Cross bar stool h.75 cm is produced with a single injection of polypropylene reinforced with glass fiber obtained by means of the latest generation of air moulding technology with neutral tones. For indoor and outdoor use.



White



Dark Grey



Black



Taupe



Olive Green

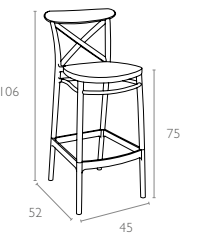

264 CROSS BAR 65

Cross bar stool h.65 cm is produced with a single injection of polypropylene reinforced with glass fiber obtained by means of the latest generation of air moulding technology with neutral tones. For indoor and outdoor use.



White



Dark Grey



Black



Taupe



Olive Green

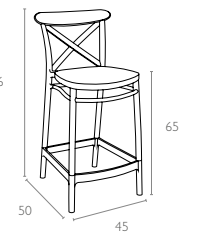

269 MARCEL BAR 75

Marcel bar stool h.75 cm is produced with a single injection of polypropylene reinforced with glass fiber obtained by means of the latest generation of air moulding technology with neutral tones. For indoor and outdoor use.



White



Dark Grey



Black



Taupe



Olive Green

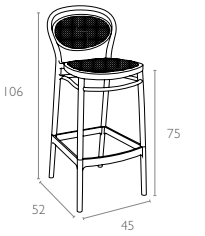

268 MARCEL BAR 65

Marcel bar stool h.65 cm is produced with a single injection of polypropylene reinforced with glass fiber obtained by means of the latest generation of air moulding technology with neutral tones. For indoor and outdoor use.



White



Dark Grey



Black



Taupe



Olive Green

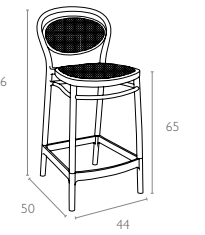

099 MAYA BAR 75

Maya stacking bar stool h.75 cm is produced with a single injection of polypropylene reinforced with glass fiber obtained by means of the latest generation of air moulding technology with neutral tones. For indoor and outdoor use.



White



Dark Grey



Black



Taupe



Olive Green

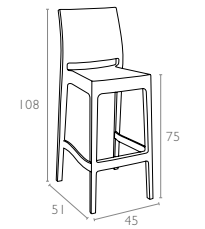

100 MAYA BAR 65

Maya stacking bar stool h.65 cm is produced with a single injection of polypropylene reinforced with glass fiber obtained by means of the latest generation of air moulding technology with neutral tones. For indoor and outdoor use.



White



Dark Grey



Black



Taupe



Olive Green

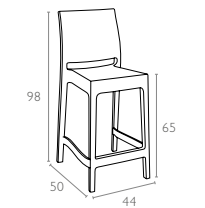

101 ARES BAR 75

Ares stacking bar stool h.75 cm is produced with a single injection of polypropylene reinforced with glass fiber obtained by means of the latest generation of air moulding technology with neutral tones. For indoor and outdoor use.



White



Dark Grey



Black



Brown



Taupe

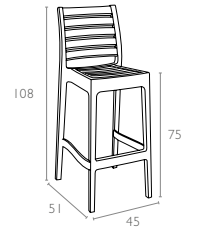

073 OPERA BAR 75

Stacking wedding bar stool h.75 cm for indoor and outdoor use in clear or shiny polycarbonate. Scratch resistant, UV - resistant.



Glossy White



Amber Transparent



Clear Transparent

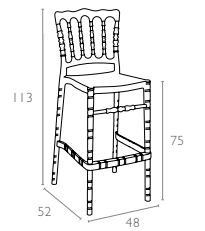

074 OPERA BAR 65

Stacking wedding bar stool h.65 cm for indoor and outdoor use in clear or shiny polycarbonate. Scratch resistant, UV - resistant.



Glossy White



Amber Transparent



Clear Transparent

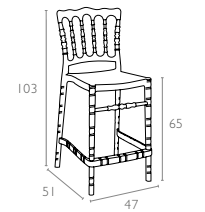

083 CHIAVARI BAR 75

Stacking wedding bar stool h.75 cm for indoor and outdoor use in clear or shiny polycarbonate. Scratch resistant, UV - resistant.



Glossy White



Amber Transparent



Clear Transparent

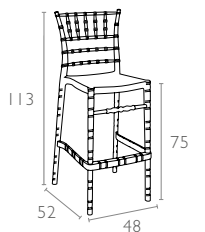

084 CHIAVARI BAR 65

Stacking wedding bar stool h.65 cm for indoor and outdoor use in clear or shiny polycarbonate. Scratch resistant, UV - resistant.



Glossy White



Amber Transparent



Clear Transparent

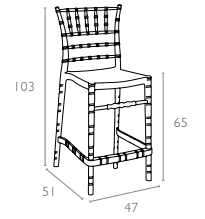
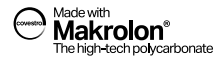

037 FOX 75

Stacking bar stool h.75 cm for indoor and outdoor use in shiny technopolymer PA6 nylon or clear polycarbonate. Scratch resistant, self - extinguish classification V2, UV - resistant.



Glossy White



Glossy Red



Clear Transparent



Smoke Grey Transparent



Amber Transparent



Black Transparent

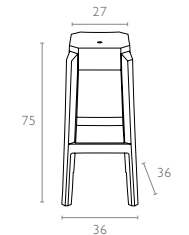
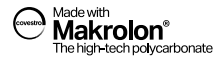

036 FOX 65

Stacking bar stool h.65 cm for indoor and outdoor use in shiny technopolymer PA6 nylon or clear polycarbonate. Scratch resistant, self - extinguish classification V2, UV - resistant.



Glossy White



Glossy Red



Clear Transparent



Black Transparent

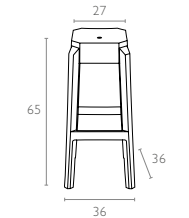
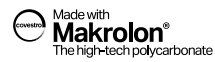

068 AIR BAR 75

Air Bar stool h.75 cm is produced with a single injection of polypropylene reinforced with glass fiber obtained by means of the latest generation of air moulding technology with neutral tones. For indoor and outdoor use.



White



Orange



Dark Grey



Black



Taupe



Red



Tropical Green

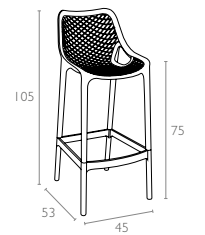

067 AIR BAR 65

Air Bar stool h.65 cm is produced with a single injection of polypropylene reinforced with glass fiber obtained by means of the latest generation of air moulding technology with neutral tones. For indoor and outdoor use.



White



Orange



Dark Grey



Black



Taupe



Red



Tropical Green

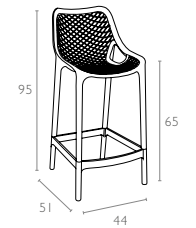

042 ARIA

Revolving stool with adjustable height with gas piston. Base and column in stainless steel. Seat in recyclable polycarbonate. For indoor use.

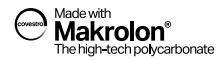

Glossy White



Clear Transparent



Black Transparent



Red Transparent



Amber Transparent

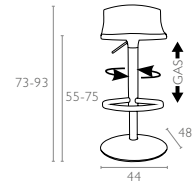

035 GIO 75

Stacking bar stool with recyclable polypropylene seat and backrest and square anodized aluminium legs. Diameter 25x25 mm. For indoor and outdoor use.



White



Beige



Red



Orange



Light Green



Black

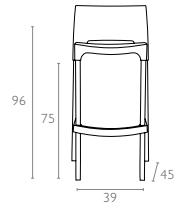

065 QUEEN

Stacking side table for indoor and outdoor use in clear polycarbonate. UV - resistant.



Glossy White



Clear Transparent



Black Transparent



Amber Transparent

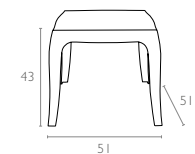

109 SKY SIDE TABLE

Sky Side Table is made of durable weather-resistant resin. Non-metallic frame will never unravel, rust or decay. It is UV protected which insures the colors will not fade. Can be disassembled. For indoor and outdoor use.



White



Dark Grey



Black



Taupe



Red



Yellow

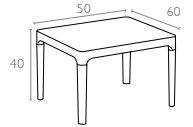

104 SKY LOUNGE TABLE

Sky Table is made of durable weather-resistant resin. Metallic frame will never unravel, rust or decay. It is UV protected which insures the colors will not fade. Can be disassembled. For indoor and outdoor use.



White



Dark Grey



Black



Taupe



Red



Yellow

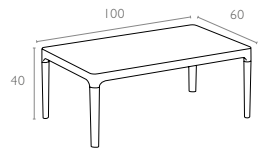

CATAS
TEST REPORT
257118

064 BOX TABLE

Stacking table in recyclable polypropylene. For indoor and outdoor use.



White



Silver Grey



Dark Grey



Black



Red



Orange



Tropical Green

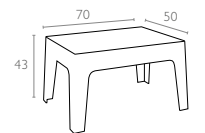

066 OCEAN SIDE TABLE

Ocean Side Table is made of durable weather-resistant resin. Non-metallic frame will never unravel, rust or decay. It is UV protected which insures the colors will not fade. Can be disassembled. For indoor and outdoor use.



White



Taupe



Silver Grey



Dark Grey



Black

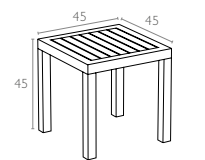

069 OCEAN TABLE

Ocean Lounge Table is made of durable weather-resistant resin. Non-metallic frame will never unravel, rust or decay. It is UV protected which insures the colors will not fade. Can be disassembled. For indoor and outdoor use.



White



Taupe



Silver Grey



Dark Grey



Black

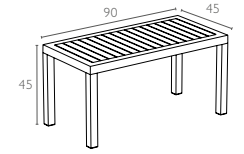

772 VEGAS TABLE

Extendible table from 100 to 140 cm in polypropylene reinforced with glass fiber. Easily expandable, giving you a choice of two size options. Smart extending mechanism makes it easy to adjust the table to your preferred size. For indoor and outdoor use with UV protection.

100x100 / 100x140 cm

CATAS
TEST REPORT
253099



White



Taupe



Dark Grey



Black

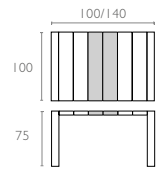

774 VEGAS TABLE MEDIUM

Extendible table from 180 to 220 cm in polypropylene reinforced with glass fiber. Easily expandable, giving you a choice of two size options. Smart extending mechanism makes it easy to adjust the table to your preferred size. For indoor and outdoor use with UV protection.

100x180 / 100x220 cm

CATAS
TEST REPORT
253098



White



Taupe



Dark Grey



Black

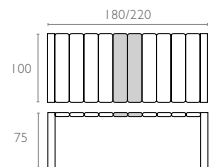

776 VEGAS TABLE XL

Extendible table from 260 to 300 cm in polypropylene reinforced with glass fiber. Easily expandable, giving you a choice of two size options. Smart extending mechanism makes it easy to adjust the table to your preferred size. For indoor and outdoor use with UV protection.

100x260 / 100x300 cm

CATAS
TEST REPORT
253097



White



Taupe



Dark Grey



Black

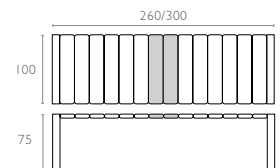

782 VEGAS BAR 100

Extendible bar table from 100 to 140 cm in polypropylene reinforced with glass fiber. Easily expandable, giving you a choice of two size options. Smart extending mechanism makes it easy to adjust the bar table to your preferred size. For indoor and outdoor use with UV protection.

100x100 / 100x140 cm

CATAS
TEST REPORT



White



Taupe



Dark Grey



Black

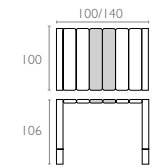

114 SKY FOLDING TABLE 60

Sky folding table is made of durable weather-resistant resin. Metallic frame will never unravel, rust or decay. It is UV protected which insures the colors will not fade. Can be disassembled.

For indoor and outdoor use.

60x60 cm



White



Taupe



Dark Grey



Black



Olive Green

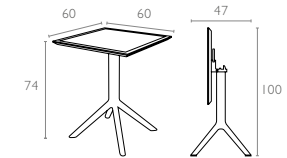

121 SKY FOLDING TABLE Ø60

Sky folding table is made of durable weather-resistant resin. Metallic frame will never unravel, rust or decay. It is UV protected which insures the colors will not fade. Can be disassembled. For indoor and outdoor use.

Ø 60 cm



White



Taupe



Dark Grey



Black



Olive Green



108 SKY TABLE 70

Sky Table is made of durable weather-resistant resin. Metallic frame will never unravel, rust or decay. It is UV protected which insures the colors will not fade. Can be disassembled.

For indoor and outdoor use.

70x70 cm



White



Taupe



Dark Grey



Black



Olive Green

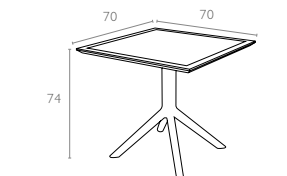

106 SKY TABLE 80

Sky Table is made of durable weather-resistant resin. Metallic frame will never unravel, rust or decay. It is UV protected which insures the colors will not fade. Can be disassembled. For indoor and outdoor use.

80x80 cm



White



Taupe



Dark Grey



Black



Olive Green

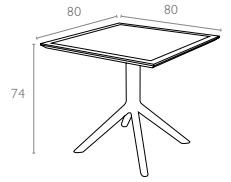

700 AIR TABLE 80

Table with plastic legs with HPL compact laminated tops 12 mm available in white and black. For indoor and outdoor use. Can be disassembled.

** Dark colors not recommended in direct sunlight.*

80x80 cm



White



Black

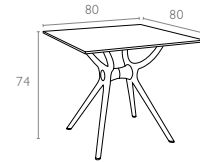

335 AIR LEGS SMALL

Air Legs are made up of polypropylene reinforced with glass fiber with the latest generation of air moulding thermoplastic injection. For indoor and outdoor use. Can be disassembled.



White



Black



Taupe

** Top min. 70x70 cm, Top max. 90x90 cm*

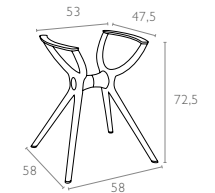

705 AIR TABLE 140

Table with plastic legs with HPL compact laminated tops 12 mm available in white and black. For indoor and outdoor use. Can be disassembled.

** Dark colors not recommended in direct sunlight.*

80x140 cm



White



Black

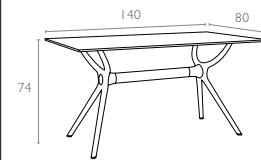

336 AIR LEGS MEDIUM

Air Legs are made up of polypropylene reinforced with glass fiber with the latest generation of air moulding thermoplastic injection. For indoor and outdoor use. Can be disassembled.



White



Black



Taupe

** Top min. 70x120 cm, Top max. 80x160 cm*

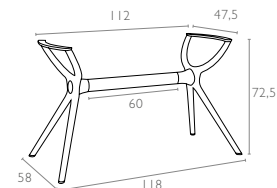

715 AIR TABLE 180

Table with plastic legs with HPL compact laminated tops 12 mm available in white and black. For indoor and outdoor use. Can be disassembled.

** Dark colors not recommended in direct sunlight.*

90x180 cm



White



Black

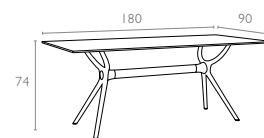

337 AIR LEGS XL

Air Legs are made up of polypropylene reinforced with glass fiber with the latest generation of air moulding thermoplastic injection. For indoor and outdoor use. Can be disassembled.

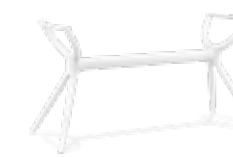

White



Black



Taupe

** Top min 90x180 cm, Top max 100x200 cm*

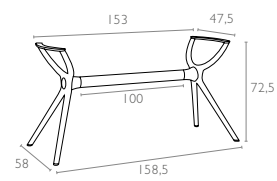

118 SKY FOLDING LEGS

Sky folding leg is made of durable weather-resistant resin. Metallic frame will never unravel, rust or decay. It is UV protected which insures the colors will not fade. Can be disassembled and suitable for werzalit or HPL compact tops. For indoor and outdoor use.



White



Black



* Top min: 50x50 cm Top max: 70x70 cm

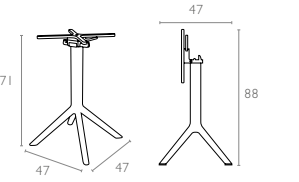

107 SKY LEGS

Sky leg is made of durable weather-resistant resin. Metallic frame will never unravel, rust or decay. It is UV protected which insures the colors will not fade. Can be disassembled and suitable for werzalit or HPL compact tops. For indoor and outdoor use.



White



Taupe



Dark Grey



Black

* Top min: 70x70 cm Top max: 90x90 cm

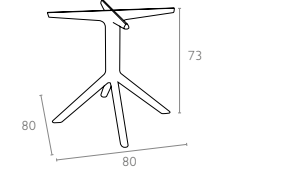

160 OCTOPUS 60

Octopus Table is made of durable weather-resistant resin. Metallic frame will never unravel, rust or decay. It is UV protected which insures the colors will not fade. Can be disassembled. For indoor and outdoor use.



White



Taupe



Silver Grey



Dark Grey



Black



Yellow

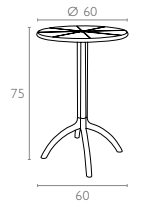

Ø 60 cm

161 OCTOPUS BAR

Octopus Bar Table is made of durable weather-resistant resin. Metallic frame will never unravel, rust or decay. It is UV protected which insures the colors will not fade. Can be disassembled. For indoor and outdoor use.



White



Taupe



Dark Grey



Black



Ø 60 cm

116 SKY FOLDING BAR TABLE 60

Sky folding bar table is made of durable weather-resistant resin. Metallic frame will never unravel, rust or decay. It is UV protected which insures the colors will not fade. Can be disassembled. For indoor and outdoor use.
60x60 cm



White



Taupe



Dark Grey



Black



Olive Green

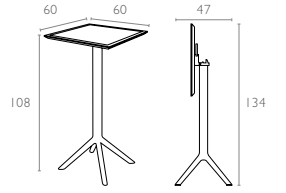

122 SKY FOLDING BAR TABLE Ø60

Sky folding bar table is made of durable weather-resistant resin. Metallic frame will never unravel, rust or decay. It is UV protected which insures the colors will not fade. Can be disassembled. For indoor and outdoor use.
Ø 60 cm



White



Taupe



Dark Grey



Black



Olive Green

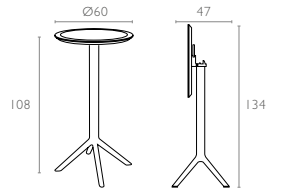

164 ARES 80

Ares 80 Table is made of durable weather-resistant resin. Non-metallic frame will never unravel, rust or decay. It is UV protected which insures the colors will not fade. Can be disassembled. For indoor and outdoor use.
80x80 cm



White

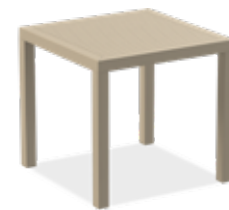

Taupe

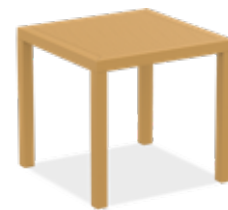

Teak



Brown



Dark Grey



Black

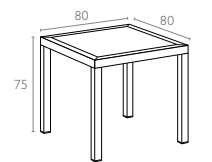

186 ARES 140

Ares 140 Table is made of durable weather-resistant resin. Non-metallic frame will never unravel, rust or decay. It is UV protected which insures the colors will not fade. Can be disassembled. For indoor and outdoor use.
80x140 cm



White



Taupe



Teak



Brown



Dark Grey



Black

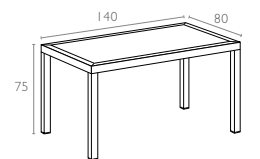

685 MAYA 80

HPL compact laminated tops
12 mm with the latest generation
of air moulding thermoplastic legs.
For indoor and outdoor use.
Can be disassembled.

** Dark colors not recommended in direct sunlight.*

80x80 cm



White

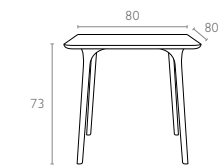

Black

**675 MAYA 120**

HPL compact laminated tops
12 mm with the latest generation
of air moulding thermoplastic legs.
For indoor and outdoor use.
Can be disassembled.

** Dark colors not recommended in direct sunlight.*

Ø 120 cm



White



Black

**690 MAYA 140**

HPL compact laminated tops
12 mm with the latest generation
of air moulding thermoplastic legs.
For indoor and outdoor use.
Can be disassembled.

** Dark colors not recommended in direct sunlight.*

80x140 cm



White



Black

**500 - 510 - 520 ICE**

Table with clear transparent
polycarbonate leg and painted
aluminium base. Werzalit tops,
resistant to outdoor use, available
in white, black and silver grey.
For indoor and outdoor use.

Code 500 Ø 60 cm
Code 510 Ø 70 cm
Code 520 Ø 80 cm



White

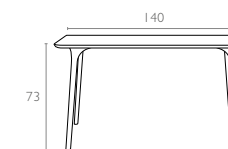

Black



Silver Grey

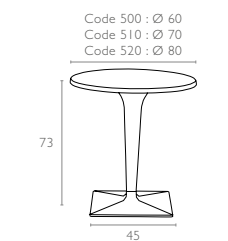

Code 500 : Ø 60
Code 510 : Ø 70
Code 520 : Ø 80



550 - 560 ICE

Table with clear transparent polycarbonate leg and painted aluminium base. Werzalit tops, resistant to outdoor use, available in white, black and silver grey. For indoor and outdoor use.

Code 550 60x60 cm
Code 560 70x70 cm



White



Black



Silver Grey

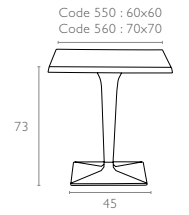

550 ICE

560 ICE

310 ICE Leg & Base

Clear transparent polycarbonate leg and painted aluminium base. For indoor and outdoor use.

Clear
Transparent

Made with
Makrolon®
The high-tech polycarbonate

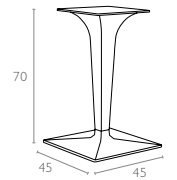

800 MANGO

Stacking table with the latest generation of air moulding thermoplastic injection. For indoor and outdoor use.

72x72 cm



White



Beige



Orange



Silver Grey

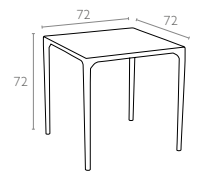

758 MANGO ALU

Stacking table with the latest generation of air moulding thermoplastic injection with legs in anodized aluminium. For indoor and outdoor use.

72x72 cm



White



Beige



Orange



Silver Grey

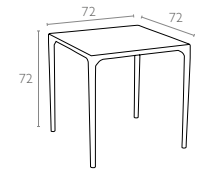

770 FORZA

Folding table with legs in anodized aluminium. Diameter 30 mm. Table top in recyclable polypropylene. For indoor and outdoor use.

80x80 cm



White

Beige

Orange

Red

Light Green

Black

Silver Grey

Teak

**750 SORTIE**

Table top in recyclable polypropylene, anodized aluminium legs. Diameter 25 mm. For indoor and outdoor use. Can be disassembled.

70x70 cm

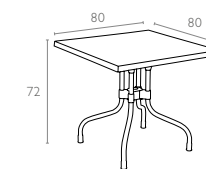
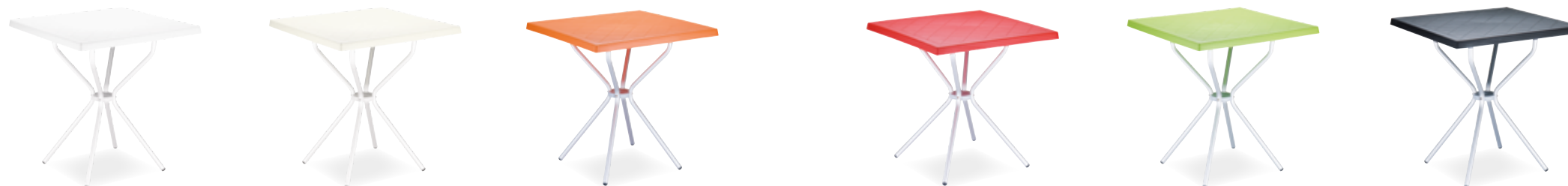

White

Beige

Orange

Red

Light Green

Black

**720 POPPY 80**

Table top in recyclable polypropylene, anodized aluminium legs. Diameter 25 mm. For indoor and outdoor use. Can be disassembled.

Ø 80 cm

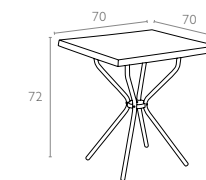

White

Beige

Orange

Red

Light Green

Black

**710 ELFO 70**

Table top in recyclable polypropylene, anodized aluminium legs. Diameter 25 mm. For indoor and outdoor use. Can be disassembled.

Ø 70 cm

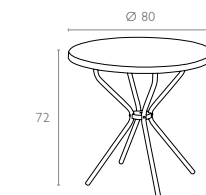

White

Beige

Orange

Red

Light Green

Black

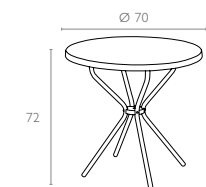

097 LINK

Link linking device in polypropylene to be fixed on the frame. Suitable for all round legs Ø 25mm.



Silver Grey

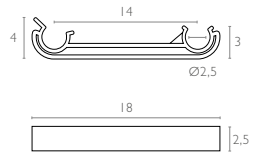

415 DODO

Suspension lamp in polycarbonate with 25W energy saving lamp. The diffuser can be removed without dismantling the electrical body, for an easy fitting and removal.

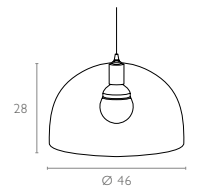

Made with **Makrolon**[®]
The high-tech polycarbonate

410 NOVA

Suspension lamp in polycarbonate with 25W energy saving lamp. The diffuser can be removed without dismantling the electrical body, for an easy fitting and removal.

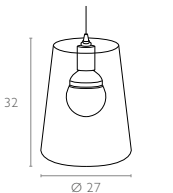

Made with **Makrolon**[®]
The high-tech polycarbonate

420 SMART

Table lamp made of transparent or coloured injected polycarbonate, with 40W lamp. Perfect gift idea.



Made with **Makrolon**[®]
The high-tech polycarbonate

899 ARTEMIS XL SEAT CUSHION

5 cm thick seat cushion covered with polyester fabric and finished with piping. Cushion is specially designed for Artemis XL armchair.



White Light Grey Beige

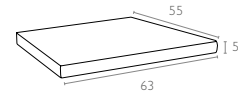

900 ARTEMIS XL BACKREST CUSHION

5 cm thick backrest cushion covered with polyester fabric and finished with piping. Cushion is specially designed for Artemis XL armchair.



White Light Grey Beige

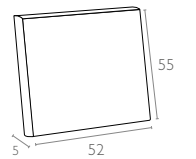

141 MYKONOS SEAT CUSHION

10 cm thick cushion covered with Etisilk polyester fabric and finished with piping. Cushions are specially designed for Mykonos Lounge Set. Water resistant with UV.



Beige Light Brown Dark Grey Black

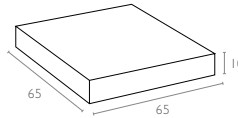

142 MYKONOS BACKREST CUSHION

10 cm thick cushion covered with Etisilk polyester fabric and finished with piping. Cushions are specially designed for Mykonos Lounge Set. Water resistant with UV.



Beige Light Brown Dark Grey Black

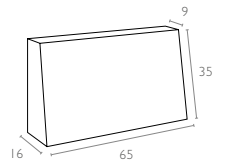

143 MYKONOS CORNER CUSHION

10 cm thick cushion covered with Etisilk polyester fabric and finished with piping. Cushions are specially designed for Mykonos Lounge Set. Water resistant with UV.



Beige Light Brown Dark Grey Black

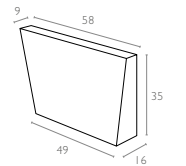

144 SLIM CUSHION

3 cm thick cushion covered with Etisilk polyester fabric and finished with piping. Cushions are specially designed for Slim sunlounger. Water resistant with UV.

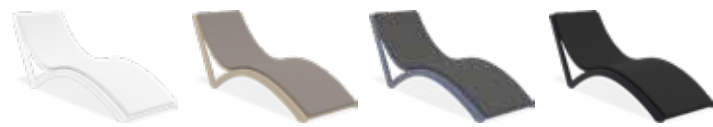

White Light Brown Dark Grey Black

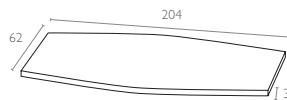

148 SLIM PILLOW CUSHION

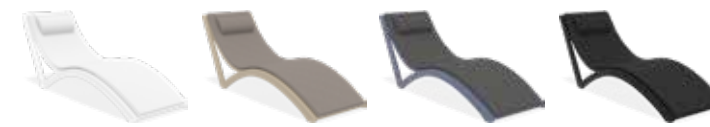

5 cm thick pillow cushion covered with Etisilk polyester fabric and finished with piping. Cushions are specially designed for Slim sunlounger. Water resistant with UV.

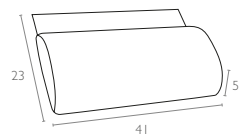

White Light Brown Dark Grey Black



notes

| INFORMATION | |
|--|---|
| <p>Technical dates and pictures in this catalogue are indicative and may not be considered binding; Siesta reserves the right to modify without notice for technical or commercial reasons the products in this catalogue. It is forbidden to re-produce the project or to re-print the catalogue.</p> | |
| <p>All dimensions are in cm.</p> | |
| <p>SYMBOLS KEY \varnothing = Diameter H = Height</p> | <p>Siesta App available on the App store</p>   |
| <p>Art Direction & Graphic Art www.adkreatik.com</p> | |



notes

A series of horizontal dashed lines for taking notes.



Siesta exclusive

www.siesta.com.tr



/SiestaFurniture



İŞILPLAST PLASTİK SANAYİ VE TİCARET A.Ş.
Ulus Mah. Çatalca Yolu Cad. No:597 Tepecik 34537
Büyükkçekmece - İSTANBUL / TURKEY
Tel: +90 212 861 50 00
Fax: +90 212 861 00 24
export@siesta.com.tr



OFFICIAL PARTNER

